

RAPIDUS

Power Factor
Controller

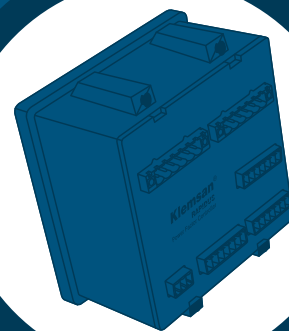
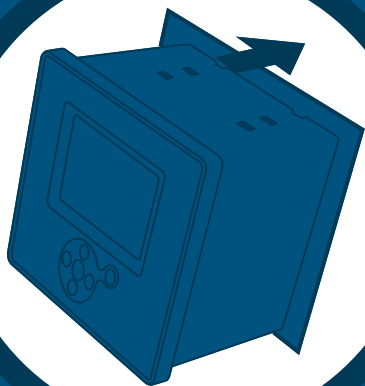

**USER
MANUAL**

Klemsan[®]

TABLE OF CONTENTS

SECTION 1	GENERAL INFORMATION	10
1.1	Symbols	10
1.2	General Warnings	10
1.3	Receipt Control and Contents of the Delivery	12
1.4	RAPIDUS Reactive Power Control Relay	13
1.5	RAPIDUS Front Panel	14
1.6	Four-Quadrant Representantion	17
SECTION 2	INSTALLATION	19
2.1	Preparation for Installation	19
2.2	Placing on the panel.....	19
2.3	Wiring Diagrams	22
2.4	Dimensions	23
SECTION 3	MENUS	25
3.1	“First Power-on” Settings	25
3.1.1	Dil / Lang. / Язык Setting	25
3.1.2	Date	26
3.1.3	Time	27
3.1.4	Current Transformer Ratio (CTR)	27
3.1.5	Voltage Transformer Ratio (VTR)	29
3.1.6	Step number	29
3.1.7	Restart.....	30
3.2	Startup Screen	30
3.2.1	Settings	31
3.2.1.1	Quick setup Menu	32
3.2.1.1.1	Language Setting	32
3.2.1.1.2	Date Menu	32
3.2.1.1.3	Time Menu	32
3.2.1.1.4	CTR.....	32
3.2.1.1.5	VTR.....	32
3.2.1.1.6	Step number	32
3.2.1.2	Setup Menu	33
3.2.1.2.1	Network Menu.....	34
3.2.1.2.1.1	CTR Setting	34
3.2.1.2.1.2	VTR Setting	35
3.2.1.2.1.3	Demand period setting	35
3.2.1.2.2	Step Menu.....	36
3.2.1.2.2.1	Ent. Power Menu.....	36
3.2.1.2.2.2	Ent. Type Menu.....	36
3.2.1.2.2.3	Predefined Menu	37
3.2.1.2.2.3.1	Structure Menu	38
3.2.1.2.2.3.2	Power Menu	38
3.2.1.2.2.3.3	Number Menu	38
3.2.1.2.2.4	Other Menu	39

3.2.1.2.3	Compensation Menu	39
3.2.1.2.3.1	Steps Menu	39
3.2.1.2.3.2	Program Menu.....	40
3.2.1.2.3.2.1	Rapidus Program	41
3.2.1.2.3.2.2	Ascending Sequential program	41
3.2.1.2.3.2.3	Descending Sequential Mode	43
3.2.1.2.3.2.4	Linear Mode.....	45
3.2.1.2.3.2.5	Circular Mode.....	47
3.2.1.2.3.2.6	Manual program	49
3.2.1.2.3.3	Target 1 Menu.....	50
3.2.1.2.3.4	Target 2 Menu.....	50
3.2.1.2.3.5	Target Low Lim. Menu	50
3.2.1.2.3.6	Target High Lim. Menu	50
3.2.1.2.3.7	Activation Time Menu.....	51
3.2.1.2.3.8	Deactivation Time Menu.....	51
3.2.1.2.3.9	Shift Angle Menu	51
3.2.1.2.3.10	Averaging Time	52
3.2.1.2.3.11	Fixed Steps Menu	52
3.2.1.2.4	Learn Menu.....	52
3.2.1.2.4.1	Learn Conn. Menu	53
3.2.1.2.4.1.1	Learn at start	53
3.2.1.2.4.1.2	Step number	54
3.2.1.2.4.1.3	Retry Timer.....	54
3.2.1.2.4.1.4	Retry Number	55
3.2.1.2.4.2	Learn Step Menu.....	55
3.2.1.2.4.2.1	Learn at start	56
3.2.1.2.4.3	Aux. Input Menu	56
3.2.1.2.4.4	Off mod	56
3.2.1.2.4.5	Night/Day Mode	56
3.2.1.2.4.6	Generator Mode.....	57
3.2.1.2.5	Device Menu	57
3.2.1.2.5.1	Language Setting	58
3.2.1.2.5.2	Contrast Setting	58
3.2.1.2.5.3	Pass. Protection	58
3.2.1.2.5.4	New Password Setting.....	59
3.2.1.2.5.5	Display On Setting	59
3.2.1.2.5.6	Display On Time Setting	59
3.2.1.2.6	Energy Menu	60
3.2.1.2.6.1	Start of day setting.....	60
3.2.1.2.6.2	Start of month setting	60
3.2.1.2.6.3	kWh Setting	60
3.2.1.2.6.4	kWh E. Setting.....	60
3.2.1.2.6.5	kVArh I. Setting.....	61
3.2.1.2.6.6	kVArh C. Setting	61
3.2.1.2.7	Communication Menu.....	61
3.2.1.2.7.1	Baud Rate Menu.....	61

3.2.1.2.7.2	Slave Id Menu.....	61
3.2.1.2.8	Alarm Menu.....	62
3.2.1.2.8.1	Energy Alarm Menu.....	62
3.2.1.2.8.2	V(L-N) Alarm Menu.....	63
3.2.1.2.8.3	V(L-L) Alarm Menu.....	65
3.2.1.2.8.4	Current Alarm Menu.....	65
3.2.1.2.8.5	P Alarm Menu.....	65
3.2.1.2.8.6	Q Alarm Menu.....	65
3.2.1.2.8.7	S Alarm Menu.....	65
3.2.1.2.8.8	CosØ Alarm Menu.....	65
3.2.1.2.8.9	PF Alarm Menu.....	65
3.2.1.2.8.10	Step Alarm Menu.....	65
3.2.1.2.8.11	IN Alarm Menu.....	66
3.2.1.2.8.12	F Alarm Menu.....	66
3.2.1.2.8.13	V Harmonics Alarm Menu.....	66
3.2.1.2.8.14	I Harmonics Alarm Menu.....	67
3.2.1.2.8.15	Temperature Alarm Menu.....	67
3.2.1.2.9	Clear Menu.....	68
3.2.1.3	Date/Time Menu.....	70
3.2.1.4	System Info Menu.....	70
3.2.1.5	Password Menu.....	71
3.2.1.6	Restart Menu.....	71
3.2.1.7	Default Settings.....	72
3.2.2	Measure Menu.....	72
3.2.2.1	Instantaneous Menu.....	73
3.2.2.2	Energy Menu.....	73
3.2.2.2.1	Imp. Active Menu (Imported Active Energy Menu).....	74
3.2.2.2.2	Exp. Active Menu (Exported Active Energy Menu).....	76
3.2.2.2.3	Ind. Reactive Menu (Inductive Reactive Energy Menu).....	76
3.2.2.2.4	Cap. Reactive Menu (Capacitive Reactive Energy Menu).....	76
3.2.2.3	Demand Menu.....	76
3.2.2.3.1	Current Menu.....	77
3.2.2.3.1.1	Act. Power Menu.....	78
3.2.2.3.1.2	Rea. Power Menu.....	78
3.2.2.3.1.3	App. Power Menu.....	78
3.2.2.4	Phasor diagram Menu.....	78
3.2.2.5	Harmonics Menu.....	79
3.2.2.5.1	Table Menu.....	79
3.2.2.5.2	Graphic Menu.....	80
3.2.3	Comp. (Compensation) Menu.....	80
3.2.3.1	Switch Count Menu.....	81
3.2.3.2	Conn. Time Menu.....	81
3.2.3.3	DCM (Dynamic Capacitor Monitoring).....	82
3.2.3.4	Learn Conn. Menu.....	82
3.2.3.5	Learned Conn. Menu.....	83
3.2.3.6	Learn Steps Menu.....	84
3.2.3.7	Learn Step Menu.....	84

3.2.4	Alarms Menu	84
3.2.4.1	Phase1 Menu.....	85
3.2.4.2	Phase2 Menu.....	86
3.2.4.3	Phase3 Menu.....	86
3.2.4.4	Step Menu.....	86
3.2.4.5	Other Menu	87
3.2.5	Analysis Menu	87
3.2.5.1	Minimum Menu	88
3.2.5.1.1	Hourly Menu.....	88
3.2.5.1.1.1	Phase1 Menu	88
3.2.5.1.1.2	Phase2 Menu.....	88
3.2.5.1.1.3	Phase3 Menu.....	89
3.2.5.1.1.4	Other	89
3.2.5.1.2	Daily Menu	89
3.2.5.1.3	Monthly Menu	89
3.2.5.2	Maximum Menu.....	89
3.2.5.3	Average Menu	89
3.2.5.4	Energy Menu.....	90
3.2.5.4.1	Hourly Menu.....	90
3.2.5.4.2	Daily Menu.....	90
3.2.5.4.3	Monthly Menu	90

SECTION 4 MODBUS PROTOCOL.....92

4.1	RS485 Wiring Diagram	92
4.2	Computer Connection	92
4.3	Message Format and Data Types of MODBUS-RTU Protocol	93
4.4	Implemented functions for MODBUS-RTU Protocol.....	93
4.5	Data and Setting Parameters for RAPIDUS	94
4.5.1	Measured and Calculated Data	94
4.5.1.1	Readable Data for RAPIDUS 231R-E.....	95
4.5.1.1.1	Alarm Flags(RAPIDUS 231R-E).....	107
4.5.1.2	Readable Data for RAPIDUS 232R-E.....	109
4.5.1.2.1	Alarm Flags(RAPIDUS 232R-E).....	122
4.5.2	RAPIDUS Setting Parameters	123
4.5.2.1	Setting for RAPIDUS 231R-E	124
4.5.2.2	Setting Parameters for RAPIDUS 232R-E	129
4.5.3	ARCHIVE (HISTORY) RECORDS	136
4.5.3.1	Hourly archive data	138
4.5.3.2	Daily archive data	140
4.5.3.3	Monthly archive data	140
4.5.4	Clear(Common for RAPIDUS 231R-E and RAPIDUS 232R-E).....	141

SECTION 5 FACTORY PRESETS..... 143

SECTION 6 TECHNICAL SPECIFICATIONS..... 149

FIGURES

Fig. 1-1	RAPIDUS 231R-E.....	14
Fig. 1-2	RAPIDUS 232R-E.....	15
Fig. 1-3	RAPIDUS with 24 RELAYS	16
Fig. 1-4	Step Information Screen for RAPIDUS 232R-E	16
Fig. 1-5	Four-Quadrant Representation	17
Fig. 2-1	Placing RAPIDUS on the Panel.....	19
Fig. 2-2	Securing RAPIDUS	20
Fig. 2-3	Loosening of the Terminal Screws.....	20
Fig. 2-4	Inserting Cable into the Terminal Block	21
Fig. 2-5	Fixing the Cable to the Terminal Block	21
Fig. 2-6	RAPIDUS Connection Diagram (12 Steps)	22
Fig. 2-7	Rapidus Connection Diagram (24 Steps).....	22
Fig. 2-8	Dimensions.....	23
Fig. 3-1	First Operation Settings	25
Fig. 3-2	Dil / Lang./ Язык Setting	25
Fig. 3-3	Date Setting.....	26
Fig. 3-4	Date Setting Example	26
Fig. 3-5	Current Transformer Ratio	27
Fig. 3-6	Entering a Value in Virtual Keyboard	28
Fig. 3-7	Voltage Transformer Ratio.....	29
Fig. 3-8	Step Structure	29
Fig. 3-9	Restart.....	30
Fig. 3-10	Startup Screen when the Connections Are Being Learned.....	30
Fig. 3-11	Startup Screen after the Connections Are Learned	31
Fig. 3-12	Settings Menu.....	31
Fig. 3-13	Quick Setup Menu.....	32
Fig. 3-14	RAPIDUS Prompt for saving	33
Fig. 3-15	Network Menu.....	34
Fig. 3-16	Current Transformer Ratio Setting	34
Fig. 3-17	Voltage Transformer Ratio Setting	35
Fig. 3-18	Demand Period Setting.....	35
Fig. 3-19	Step Menu	36
Fig. 3-20	Ent. Power Menu.....	36
Fig. 3-21	Ent. Type Menu	37
Fig. 3-22	Predefined Menu	37
Fig. 3-23	Other Menu	39
Fig. 3-24	Compensation Menu	39
Fig. 3-25	Program Menu.....	40
Fig. 3-26	RAPIDUS Mode Compensation Steps	41
Fig. 3-27	RAPIDUS Asc. Sequential Mode	42
Fig. 3-28	RAPIDUS Des. Sequential Mode.....	44
Fig. 3-29	RAPIDUS Linear Mode	46
Fig. 3-30	RAPIDUS Circular Mode.....	48
Fig. 3-31	Manual Mode Menu	49
Fig. 3-32	RAPIDUS with 24 RELAYS	49

Fig. 3-33	Step Information Screen for RAPIDUS 232R-E	50
Fig. 3-34	Averaging Time Menu.....	52
Fig. 3-35	Fixed Steps Menu	52
Fig. 3-36	Connection Setup	53
Fig. 3-37	Learning Connections at the Startup.....	54
Fig. 3-38	Waiting Time After Unsuccessful Connection Learning	54
Fig. 3-39	Retry Timer.....	55
Fig. 3-40	Retry Count.....	55
Fig. 3-41	Learn step.....	55
Fig. 3-42	Aux. Input.....	56
Fig. 3-43	Device Menu	57
Fig. 3-44	Contrast Setting.....	58
Fig. 3-45	Pass. Protection	58
Fig. 3-46	New Password Entry.....	59
Fig. 3-47	Display On Time Setting.....	59
Fig. 3-48	Energy Menu.....	60
Fig. 3-49	Baud Rate Setting.....	61
Fig. 3-50	Slave Id Setting.....	61
Fig. 3-51	Alarm Menu	62
Fig. 3-52	Energy Menu.....	62
Fig. 3-53	V(L-N) Alarm Menu.....	63
Fig. 3-54	Alarm Relay Setting	63
Fig. 3-55	Alarm Time Setting	64
Fig. 3-56	Hysteresis Setting.....	64
Fig. 3-57	Alarm Example	64
Fig. 3-58	V Harmonics Alarm Menu.....	66
Fig. 3-59	THDV High Limit Setting.....	66
Fig. 3-60	V3-V21 Harmonics High Limit Setting	67
Fig. 3-61	No Alarm Time Condition	67
Fig. 3-62	Invalid Limit	68
Fig. 3-63	Clear Menu.....	68
Fig. 3-64	Before Clearing.....	69
Fig. 3-65	After Clearing.....	69
Fig. 3-66	Initial Value Entered After Clearing	69
Fig. 3-67	Date/Time Menu.....	70
Fig. 3-68	System Info	70
Fig. 3-69	Password.....	71
Fig. 3-70	RAPIDUS Restart	71
Fig. 3-71	Default Settings	72
Fig. 3-72	Measure Menu.....	72
Fig. 3-73	Instantaneous Menu	73
Fig. 3-74	Imp. Active Energy Page	74
Fig. 3-75	Hour Start Example.....	74
Fig. 3-76	Day Start Example	75
Fig. 3-77	Month Start Example	75
Fig. 3-78	Demand Menu.....	76
Fig. 3-79	Demand Example.....	77

Fig. 3-80	Current Menu.....	77
Fig. 3-81	Phasor Diagram Menu.....	79
Fig. 3-82	Harmonics Table Menu.....	79
Fig. 3-83	Graphic Menu.....	80
Fig. 3-84	Comp. Menu.....	80
Fig. 3-85	Switch Count.....	81
Fig. 3-86	Conn. Time.....	81
Fig. 3-87	Learn Conn.....	82
Fig. 3-88	Learned Conn. Example-1.....	83
Fig. 3-89	Learned Conn. Example-1.....	83
Fig. 3-90	Learn Steps.....	84
Fig. 3-91	Learn Step.....	84
Fig. 3-92	Alarms Menu.....	85
Fig. 3-93	Phase1 Menu.....	85
Fig. 3-94	Step Menu.....	86
Fig. 3-95	Other Menu.....	87
Fig. 3-96	Analysis Menu.....	87
Fig. 3-97	Minimum Menu.....	88
Fig. 3-98	Hourly Menu.....	88
Fig. 3-99	Energy Menu.....	89
Figure 4-1	RS485 Wiring Diagram.....	92
Figure 4-2	RS485 PC Connection.....	92

TABLES

Table 4-1	Message Format.....	93
Table 4-2	int (32 bit) data type.....	93
Table 4-3	Implemented functions for MODBUS RTU Protocol.....	93
Table 4-4	Readable Data(RAPIDUS 231R-E.....	95
Table 4-5	Readable Data(RAPIDUS 232R-E).....	109
Table 4-6	Setting Parameter (Available for RAPIDUS 231R-E).....	124
Table 4-7	String List (Available for RAPIDUS 231R-E).....	129
Table 4-8	Setting Parameter (Available for RAPIDUS 232R-E).....	129
Table 4-9	String List (Available for RAPIDUS 232R-E).....	135
Table 4-10	Archive (History) Record Table.....	136
Table 4-11	Clear Address Table.....	141



RAPIDUS

Power Factor
Controller

**SECTION 1
GENERAL
INFORMATION**

SECTION 1 GENERAL INFORMATION

1.1 Symbols

Caution:

This symbol indicates that there is cautionary information where it is used.

**Danger of Electric Shock:**

This symbol indicates that there is dangerous voltage or current.

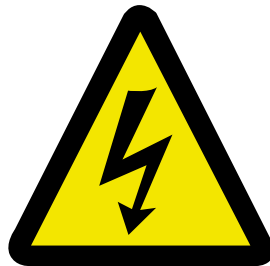

1.2 General Warnings

- Voltage measurement input connections:
Overcurrent protection is required for voltage measurement connections V1, V2 and V3: 2 Arms gL fuses (IEC 269) or M type fuses (IEC 127) with rated voltage 300 VAC.
- Compensation relay connections:
Overcurrent protection is required for compensation relay outputs. Fuses are recommended to be inserted at COM connections, namely COM1 (for 1..6 compensation relays) and COM2 (for 7..12 compensation relays). Technical details are as follows: 13 Arms gL fuses (IEC 269) or M type fuses (IEC 127) with rated voltage 300 VAC.
- Alarm relay connections:
Overcurrent protection is required for alarm relay outputs: 3 Arms gL fuses (IEC 269) or M type fuses (IEC 127) with rated voltage 300 VAC.
- It is required to use a circuit breaker in order to easily disconnect RAPIDUS from mains. Circuit breaker should have the following specifications:
 - 4 poles (one pole for each phase and the fourth pole for the neutral line),
 - 300 VAC or above rated voltage
 - 1 A or above rated current
- "Do not use this product for any other purpose than it is designed for."

- When mounted on the wall of the panel enclosure, front side of RAPIDUS will be facing the operator. The remaining of RAPIDUS will be inside an enclosure. This panel enclosure should be a fire enclosure.
- Ensure that energy supply is cut off in the panel or in all relevant systems before attempting to connect the device to mains.
- Installation and connections shall be performed by qualified persons with respect to the instructions on the user's manual.
- Device shall only be activated after all connections are made.
- We advise you to connect a 2 A fuse between the voltage inputs of the device and the mains and supply input and mains.
- We advise you to connect a 1 mm² (AWG17) cable to supply input and measure inputs; and to connect a 2 mm² (AWG14Cu) cable to the current inputs.
- Do not remove RAPIDUS current transformer connections without short circuiting the K-L ends of the current transformer to somewhere else or connecting a load adequately low impedance to the K-L ends. Otherwise, dangerous high voltages may occur on the secondary ends of the current transformer. The same applies to starting of the device.
- Device shall be placed away from damp, wet, vibrating and dusty environments.
- Use a dry cloth to clean the device or remove the dust on it. Do not use alcohol, thinner or an abrasive agent.
- Do not open the inside of the device. There are no user-maintainable components inside.



1.3 Receipt Control and Contents of the Delivery

When the RAPIDUS is delivered to you, check that:

- the packing of RAPIDUS is in good condition
- the product is not damaged during transport
- name of the product and order number is correct.

RAPIDUS Order No:	Short code	Description
606005	RAPIDUS 231R-E	Rapidus 3 phase 12 relays
606007	RAPIDUS 232R-E	Rapidus 3 phase 24 relays

Contents of the RAPIDUS packing is listed below.

- 1 RAPIDUS
- 1 CD-ROM (User's Manual)
- 4 panel tightening tools
- 1 pc of 4-pin female terminal for alarm outputs (NO, C/out2, C/out1, NO)
- 1 pc of 6-pin female terminal for current inputs (I1, k1, I2, k2, I3, k3)
- 1 pc of 4-pin female terminal for voltage input (V1, V2, V3, N)
- 2 pcs of 7-pin female terminal for step outputs (Com1, Com2, K1...K12)
- 1 pc of RS485 3-pin female terminal (D+, GND, D-)
- 1 pc of 2-pin female terminal for generator input (GenA, GenB)

NOTE: 4 pcs of 7-pin female terminal for step outputs (Com1, Com2, Com3, Com4, K1...K24) for RAPIDUS 232R-E optional model.

1.4 RAPIDUS Reactive Power Control Relay

RAPIDUS is a multi-function reactive power control relay. It measures active, reactive and total powers of the system that it is connected. As a result of these measurements, it activates capacitor and shunt reactors in the compensation panel. Thus, it compensates the system reactive power bidirectionally.

RAPIDUS counters record "imported active", "exported active", "inductive reactive" and "capacitive reactive" energy values.

All user actions can be performed easily using the 160x240 graphic LCD display and 6 keys on the front panel.

RAPIDUS has an isolated RS485 port.

It also has 2 alarm relay outputs.

RAPIDUS measures/calculates

- Current, voltage and frequency
- Active, reactive and apparent power
- Current and voltage harmonics up to 51st harmonics
- THDV, THDI
- Power factor, $\cos\phi$

values for each phase.

RAPIDUS has features such as:

- Learning connection methods
- Learning step powers and types
- Recording switching numbers and duty ratios for each step
- Compensation possibility with 6 different programs
- Determination of whether the activated step is faulty and dynamic step monitoring
- For active, reactive (inductive and capacitive) energy, values of index, hourly, previous hour, previous day, monthly and previous month
- Compensation in 12 steps
- Current and voltage harmonics measurement up to 51st harmonics
- Testing possibility for relays and steps
- Automatic calculation of C/k ratio

Also, RAPIDUS has the following features:

- Setting an alarm for various measurement parameters
- Provision of counter monitoring by assigning initial counter values
- Prevention of unauthorized usage with 4 digit password input
- Battery supported real time timer and memories

1.5 RAPIDUS Front Panel

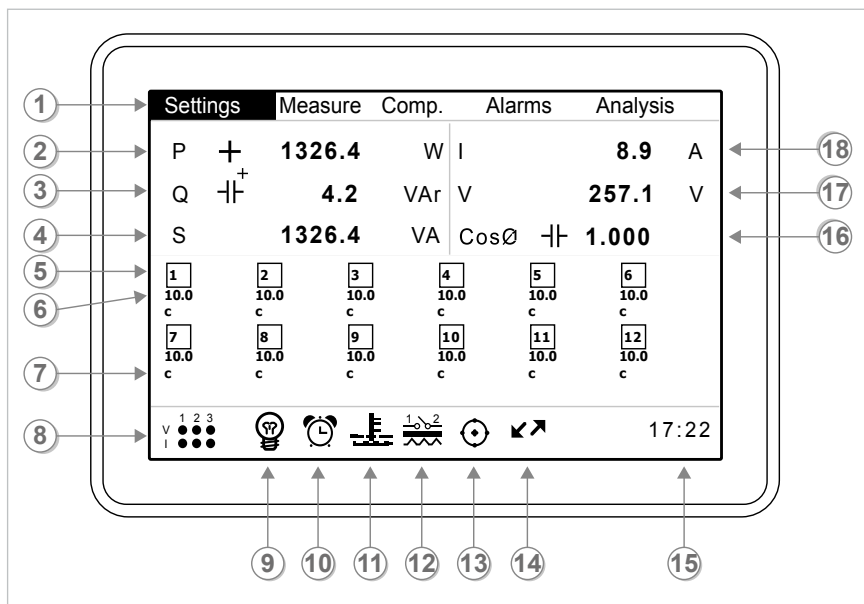

Fig. 1-1 RAPIDUS 231R-E

- 1 Menu
- 2 Total Active Power
- 3 Total Reactive Power
- 4 Total Apparent Power
- 5 Number of steps
- 6 Step power
- 7 Step type
- 8 Presence/absence of currents and voltages
- 9 Selected compensation mode
 - 💡 => Rapidus mode (Smart mode)
 - 📈 => Asc. sequential mode
 - 📉 => Des. sequential mode
 - 📊 => Lineer mode
 - 🔄 => Circular mode
 - 👉 => Manual mode
 - ⚠️ => Caution Symbol (It is displayed when learning connections are failed)
 - 🕒 => Hourglass (It is displayed when connections or step powers are being learned)
- 10 Alarm status symbol (displayed when alarm occurred in system)
- 11 Temperature alarm status symbol (displayed when an alarm occurred in the system)
- 12 Alarm relay symbol (This symbol is displayed if 1st and/or 2nd alarm relay is assigned to an alarm and an alarm is present in the system. "1" indicates 1st alarm relay, and "2" indicates 2nd alarm relay on the symbol)
- 13 Indicates that DCM is active
- 14 RS485 communication symbol
- 15 System clock
- 16 System CosØ value
- 17 Average VLL(line-line) voltages
- 18 Total Current of Three Phases

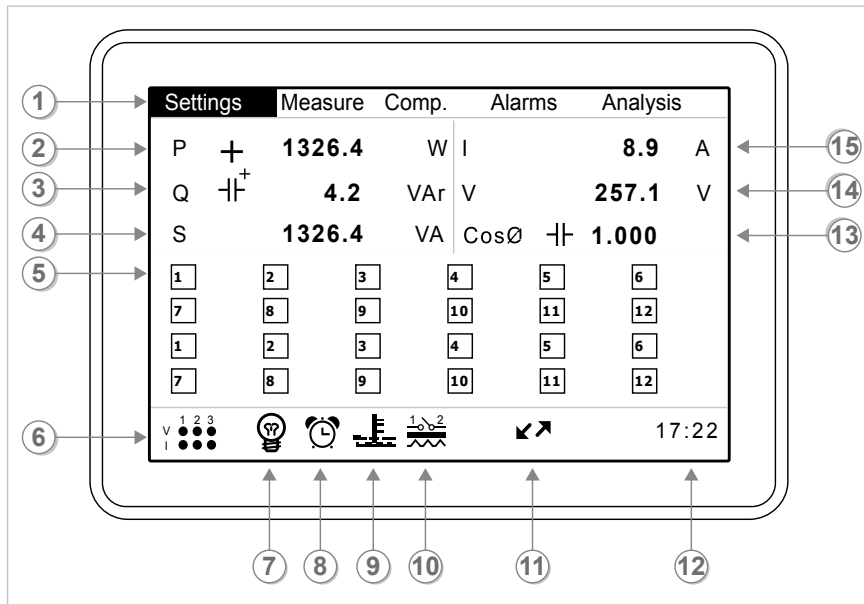

Fig. 1-2 RAPIDUS 232R-E

- 1 Menu
- 2 Total Active Power
- 3 Total Reactive Power
- 4 Total Apparent Power
- 5 Number of steps
- 6 Presence/absence of currents and voltages
- 7 Selected compensation mode
 - ⚡ => Rapidus mode (Smart mode)
 - ↑ => Asc. sequential mode
 - ↓ => Des. sequential mode
 - || => Lineer mode
 - 🔄 => Circular mode
 - 👉 => Manual mode
 - ⚠ => Caution Symbol (It is displayed when learning connections are failed)
 - 🕒 => Hourglass (It is displayed when connections or step powers are being learned)
- 8 Alarm status symbol (displayed when alarm occurred in system)
- 9 Temperature alarm status symbol (displayed when an alarm occurred in the system)
- 10 Alarm relay symbol (This symbol is displayed if 1st and/or 2nd alarm relay is assigned to an alarm and an alarm is present in the system. "1" indicates 1st alarm relay, and "2" indicates 2nd alarm relay on the symbol)
- 11 RS485 communication symbol
- 12 System clock
- 13 System CosØ value
- 14 Average VLL(line-line) voltages
- 15 Total Current of Three Phases

If operator press down key, below screen is shown.

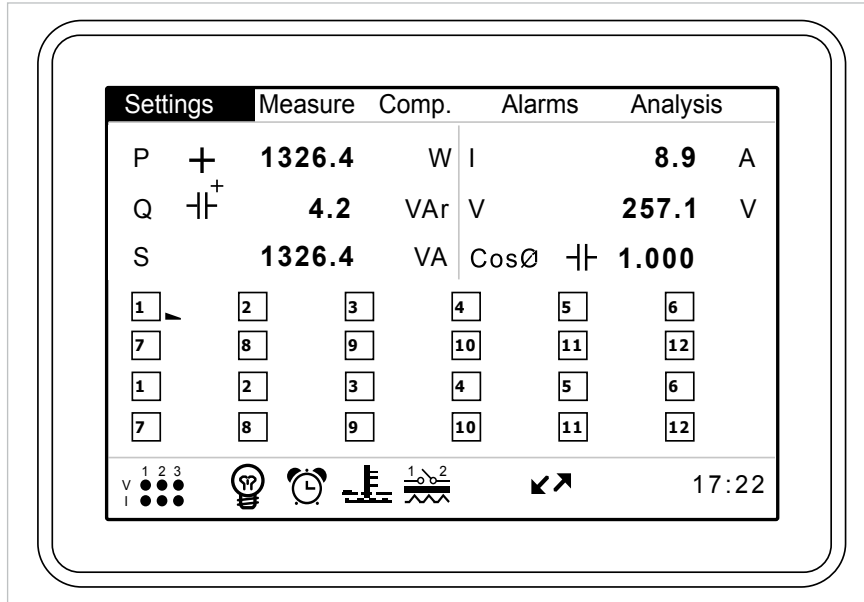

Fig. 1-3 RAPIDUS with 24 RELAYS

Operator can scroll inside steps by pressing right and left keys. When OK key is pressed below screen is shown.

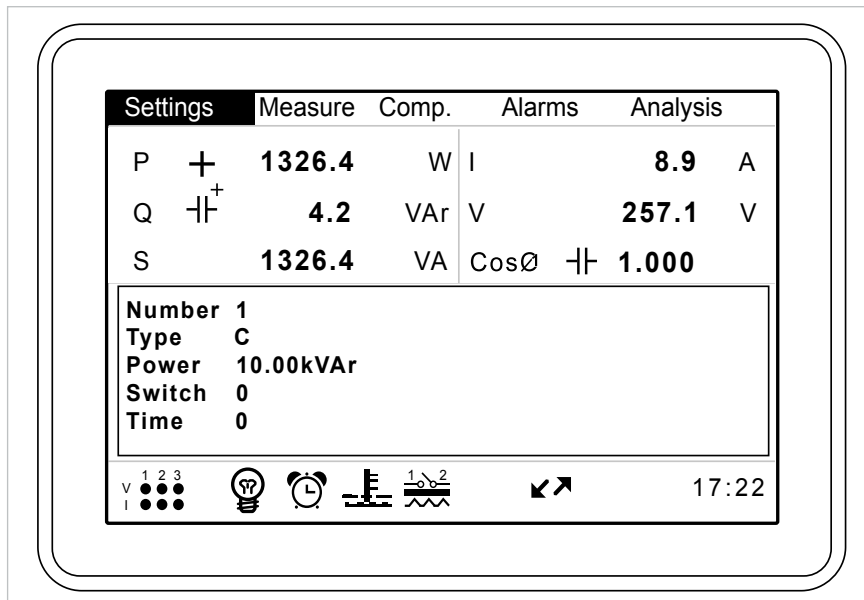

Fig. 1-4 Step Information Screen for RAPIDUS 232R-E



1.6 Four-Quadrant Representation

The angle(\emptyset) between voltage and current provides us information about the direction of energy fl w. A positive sign for active/reactive power indicates that active/reactive power is consumed.

And also a negative sign for active/reactive power indicates that active/reactive power is generated.

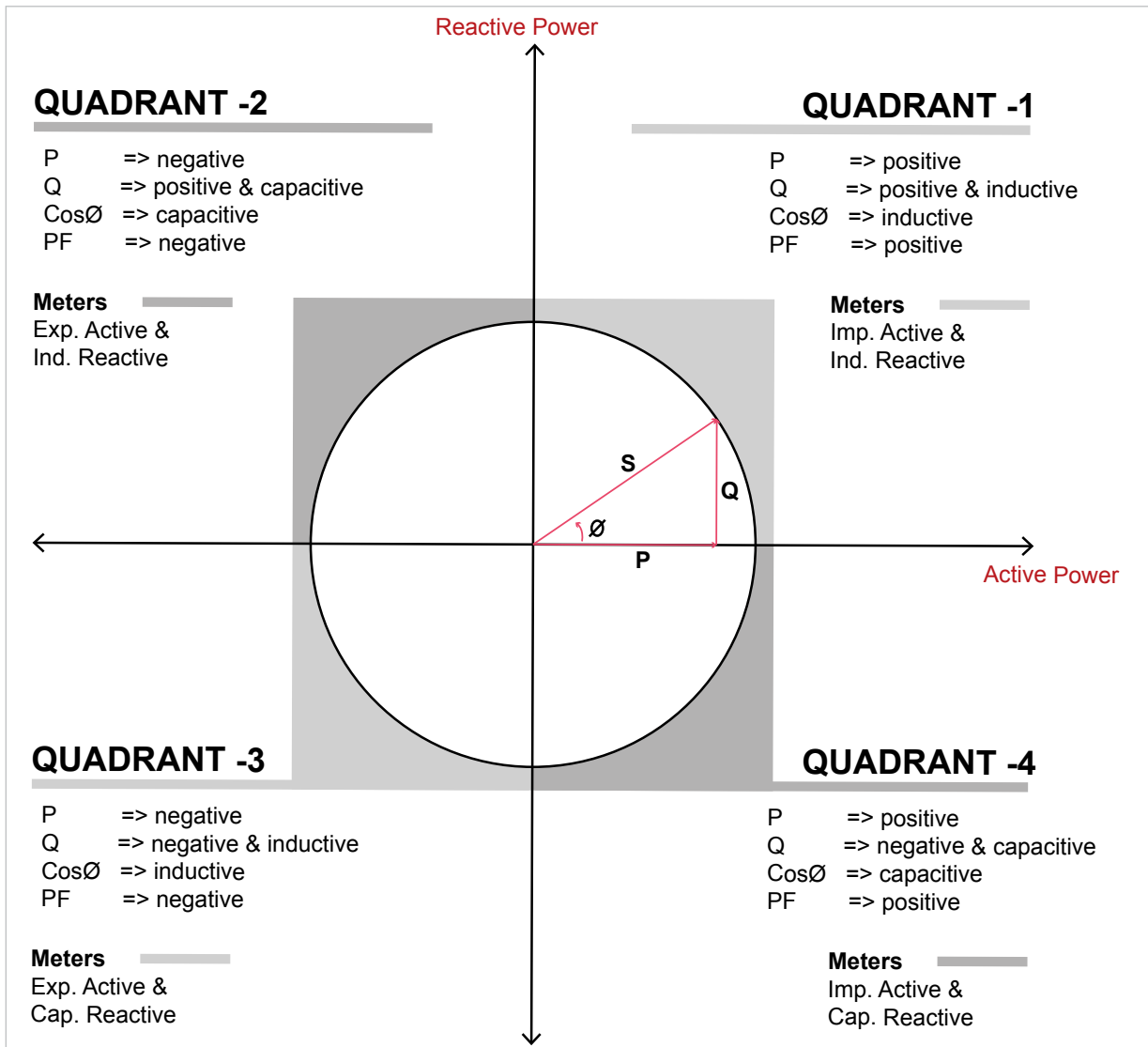

Fig. 1-5 Four-Quadrant Representation

NOTE: If the signs of active and reactive power are examined, it can be defined the quadrant that Rapidus measures.

e.g.

- P= +10kWh, Q= +5kVAr => Quadrant-1
- P= -10kWh, Q= +5kVAr => Quadrant-2
- P= -10kWh, Q= -5kVAr => Quadrant-3
- P= +10kWh, Q= -5kVAr => Quadrant-4



RAPIDUS

Power Factor
Controller

SECTION 2
INSTALLATION

SECTION 2 INSTALLATION

This section contains information on the installation, cable connections and connection methods of RAPIDUS.

2.1 Preparation for Installation

RAPIDUS that you have purchased may not include all hardware options specified in the installation manual. This is not issue for the electrical installation.



Installation and connections of RAPIDUS shall be performed by qualified persons with respect to the instructions on the user's manual.



Do not operate the device before making the connections correctly.

2.2 Placing on the panel

RAPIDUS is placed vertically on the empty compartment on the panel.

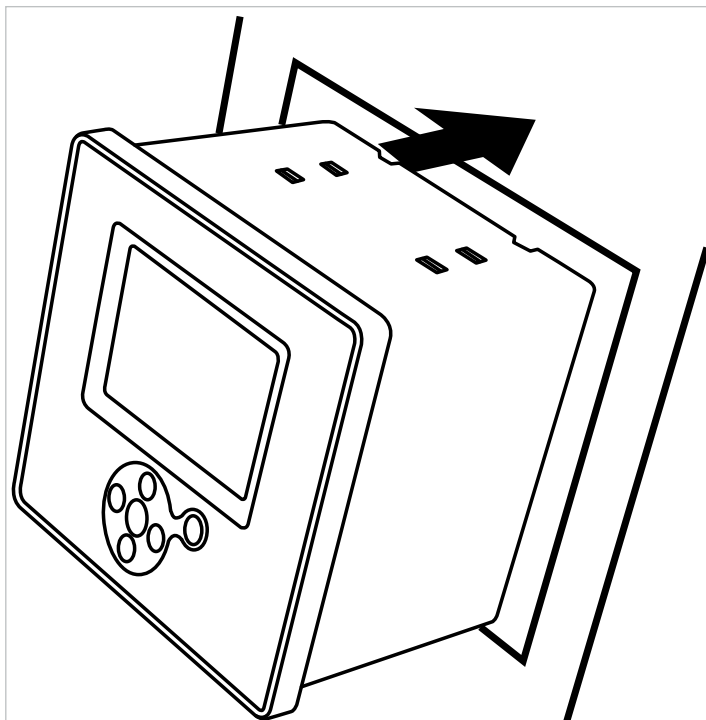

Fig. 2-1 Placing RAPIDUS on the Panel

After placing RAPIDUS on the panel tightening tool is installed and then secured by tightening its screw.

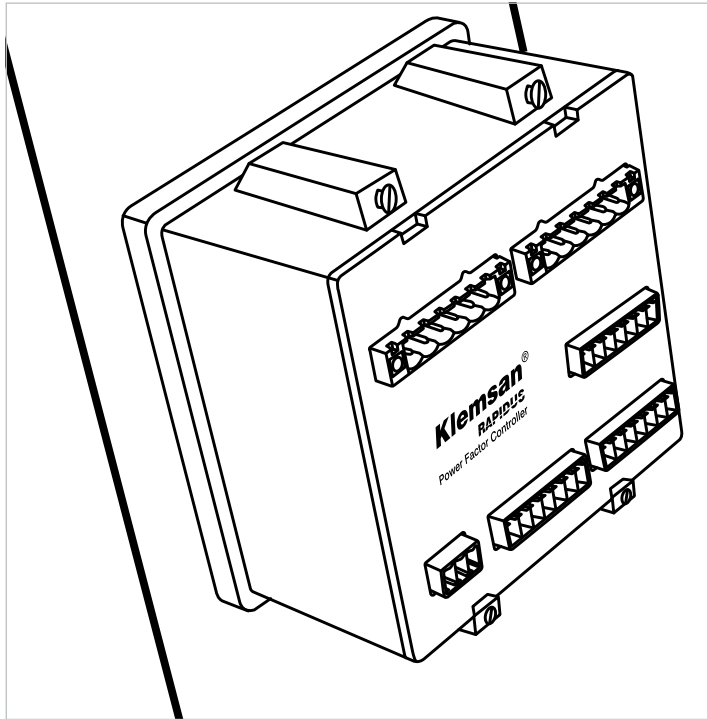

Fig. 2-2 Securing RAPIDUS

RAPIDUS has female terminals with 2.5mm² and 1.5mm² screws. Female terminal is removed on its housing on RAPIDUS (removed from the fixed male terminal). Screws on the female terminal are loosened.

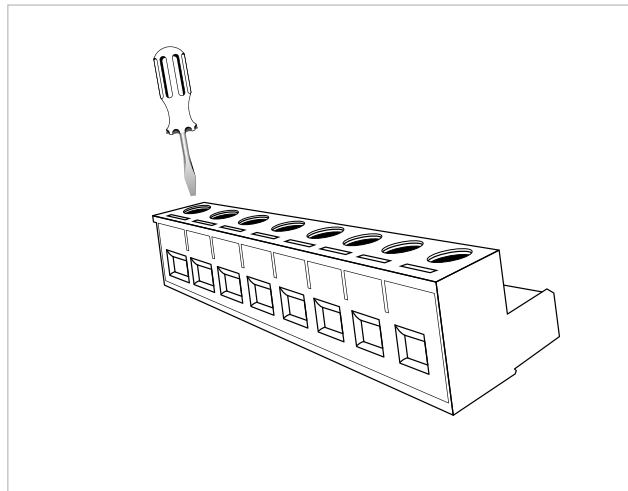

Fig. 2-3 Loosening of the Terminal Screws



Make sure that the power is cut off before connecting voltage and current ends to RAPIDUS.



Do not remove RAPIDUS current transformer connections without short circuiting the K-L ends of the current transformer to somewhere else. Otherwise, dangerous high voltages may occur on the secondary ends of the current transformer. The same applies to starting of the device.

Cable is placed in the relevant connection hole.

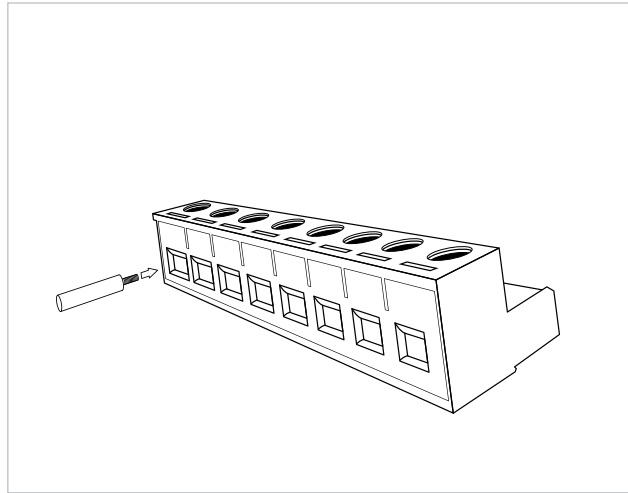

Fig. 2-4 Inserting Cable into the Terminal Block

After the cable is placed, the screws are tightened and the cable is fixed.

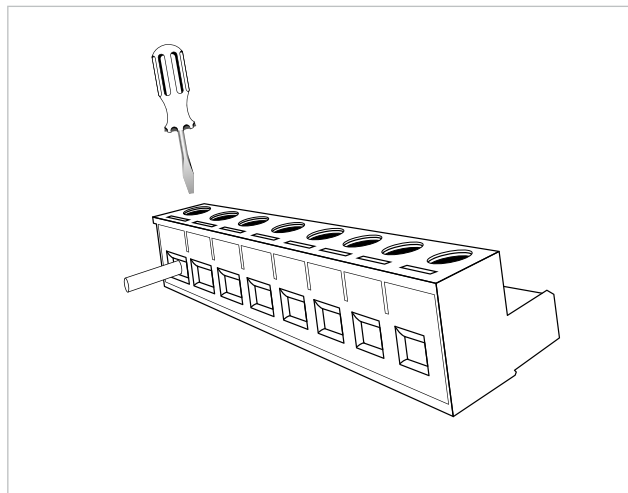

Fig. 2-5 Fixing the Cable to the Terminal Block

Terminal is placed on its housing on RAPIDUS.



Consider this warning if RAPIDUS is used with current transformers. Correct operating threshold values of transformers vary as per the type and size of the current transformers used. Please check that the measured current value is higher than the current threshold specified in the user's manual of current transformer."

2.3 Wiring Diagrams

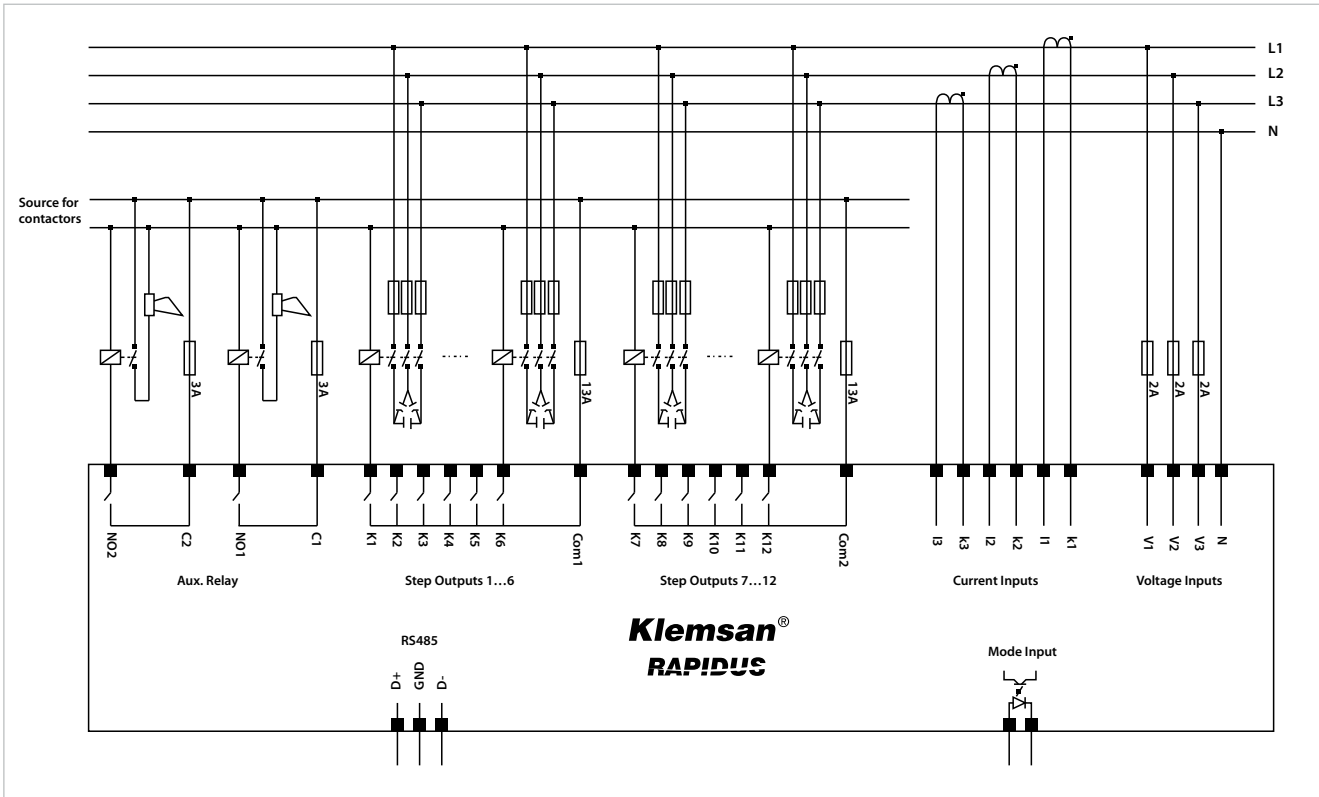

Fig. 2-6 RAPIDUS Connection Diagram (12 Steps)

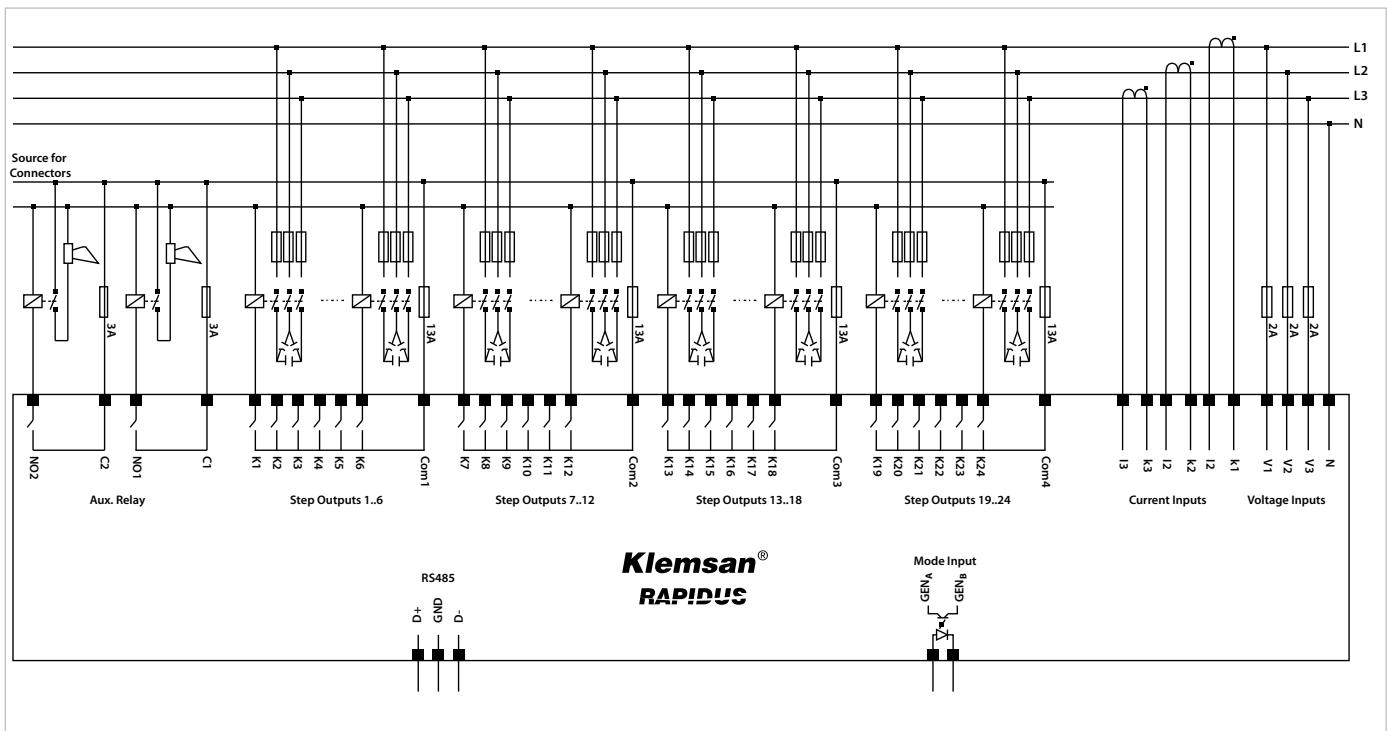

Fig. 2-7 Rapidus Connection Diagram (24 Steps)

2.4 Dimensions

Dimensions are in millimeters.

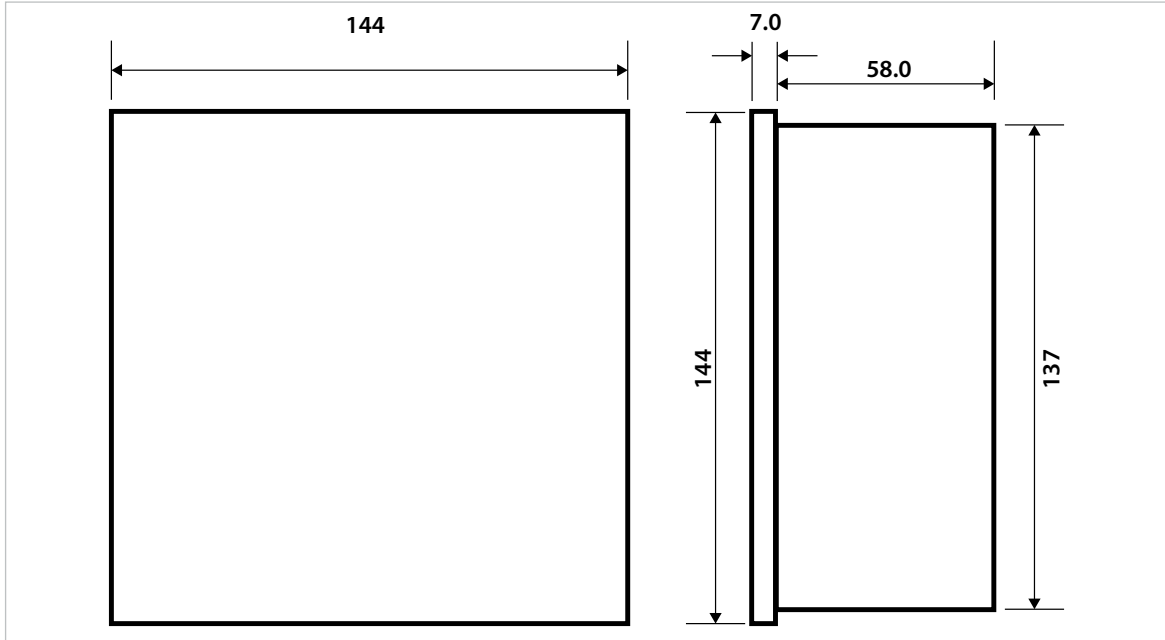

Fig. 2-8 Dimensions



RAPIDUS

Power Factor
Controller

**SECTION 3
MENUS**

SECTION 3 MENUS

3.1 “First Power-on” Settings

The following page is displayed when RAPIDUS is energized for the “first time” after it is released from the factory



Fig. 3-1 First Operation Settings

3.1.1 Dil / Lang. / Язык Setting

“Türkçe”, “English” and “Русский” language options are displayed when you press OK while this tab is selected. User shall select the desired option with up and down arrows and press “OK”. If the language is selected as English, the language settings for all other tabs shall also be English.

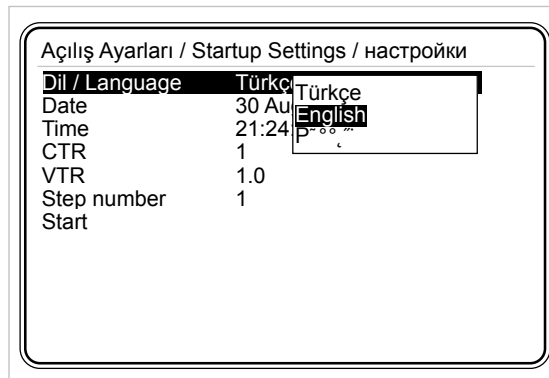

Fig. 3-2 Dil / Lang./ Язык Setting

3.1.2 Date

Date setting of RAPIDUS is performed here. Press OK when this option selected. Highlight day, month or year digits with the right and left arrow keys. Date setting is performed with up and down keys. Date setting is completed by pressing OK.



Fig. 3-3 Date Setting

Example: To select "August 30th, 2013":

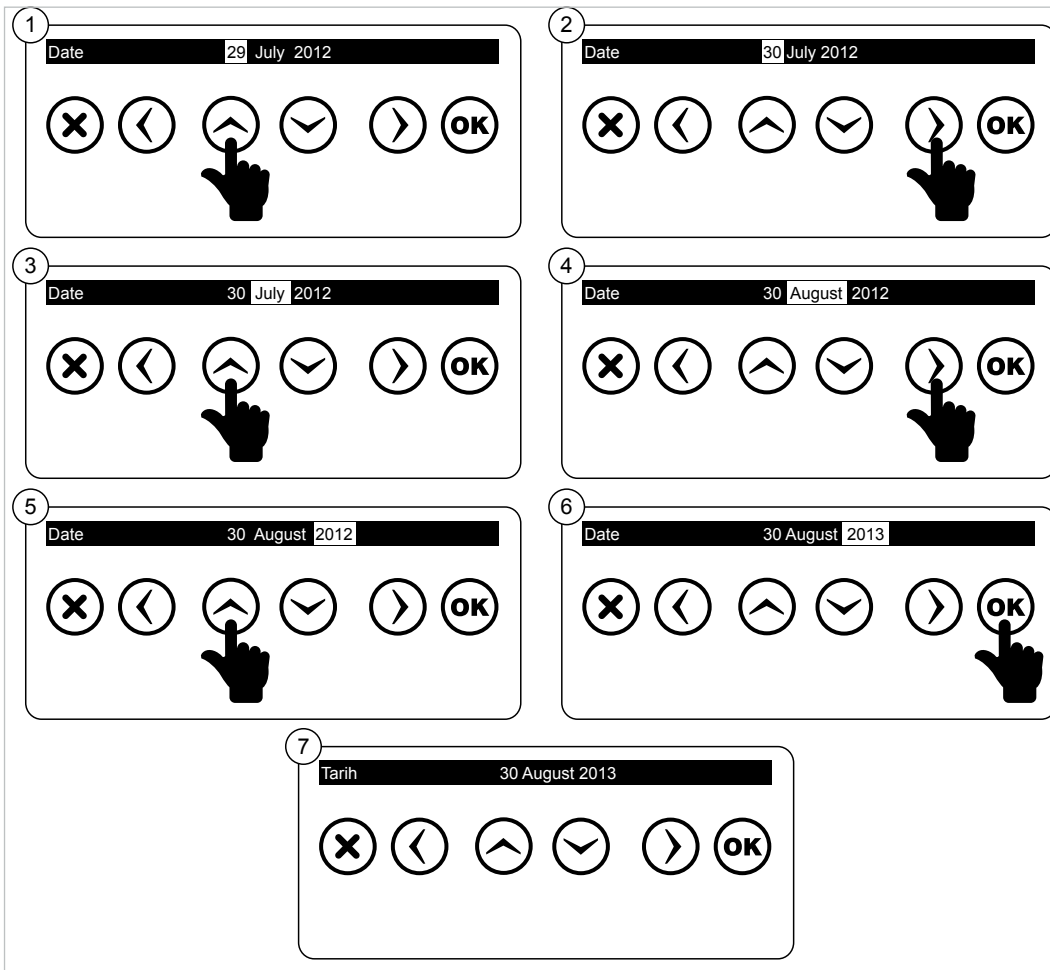

Fig. 3-4 Date Setting Example

3.1.3 Time

Time setting of RAPIDUS is performed here. It is set as described on [3.1.2 Date](#) menu.

3.1.4 Current Transformer Ratio (CTR)

This is the settings tab for entering the current transformer ratio. Current transformer ratio may be selected between 1 and 5000. RAPIDUS Virtual Keyboard shall be displayed when you press OK when this option selected.

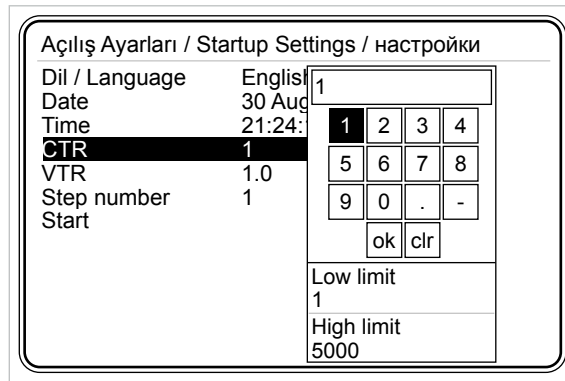

Fig. 3-5 Current Transformer Ratio

Use arrow keys to navigate between the digits and OK key to enter the selected digit as a value. If you enter an incorrect number, select **clr** box and press OK. Thus, the incorrect number entered shall be deleted.



Current transformer ratio shall be entered correctly to ensure that RAPIDUS performs a correct compensation.

Example:

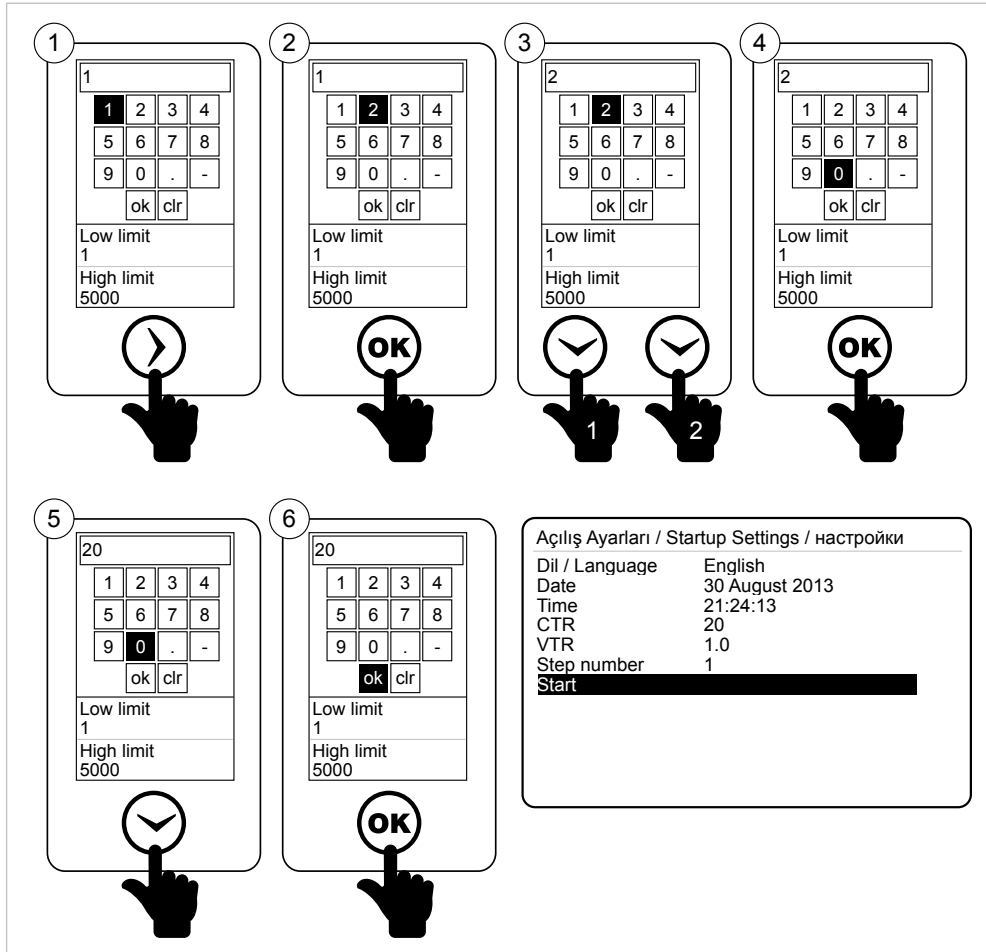

Fig. 3-6 Entering a Value in Virtual Keyboard

3.1.5 Voltage Transformer Ratio (VTR)

This is the settings tab for entering the voltage transformer ratio. Voltage transformer ratio may be selected between 1 and 5000. (For the usage of RAPIDUS Virtual Keyboard, Refer to 3.1.4 Ex.). If you will enter a number with a decimal place for voltage transformer ratio, select the box on the Virtual Keyboard with arrow keys and press OK.

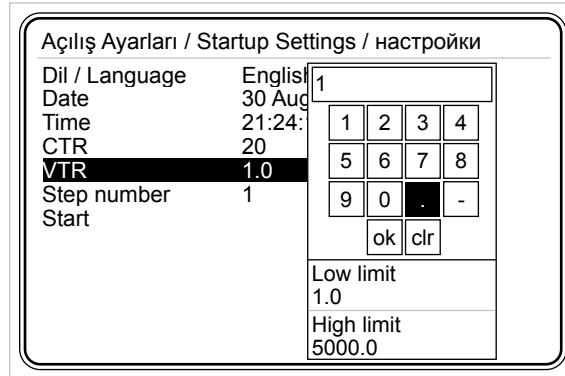

Fig. 3-7 Voltage Transformer Ratio



Voltage transformer ratio shall be entered correctly to ensure that RAPIDUS performs a correct compensation.

3.1.6 Step number

You shall enter the 3-phase capacitor step number required for learning the connections from this menu

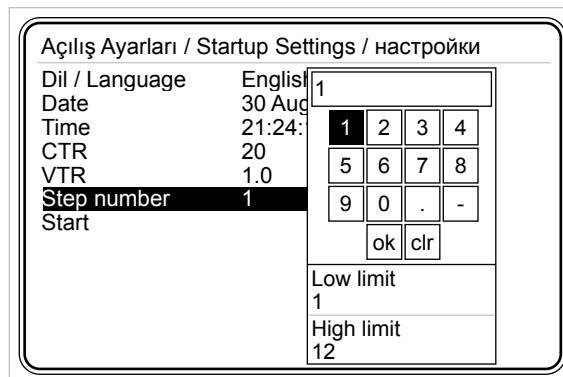

Fig. 3-8 Step Structure

3.1.7 Restart

RAPIDUS shall be restarted when you press OK when the Restart tab is highlighted.

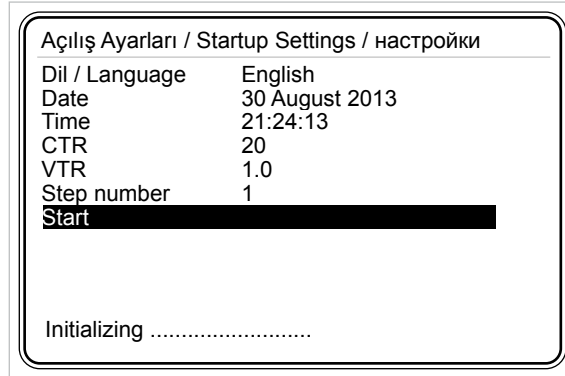

Fig. 3-9 Restart



RAPIDUS startup settings page is displayed when the RAPIDUS is powered up for the first time. After RAPIDUS is restarted, all settings (including startup settings) may be changed from the Settings menu.

3.2 Startup Screen

If "Settings=>Setup=>Learn=>Learn conn.=> learn at start" function is adjusted as "On", following screen page shall be displayed after RAPIDUS is started. Device shall learn the connections first, and then the step powers respectively when it is started.

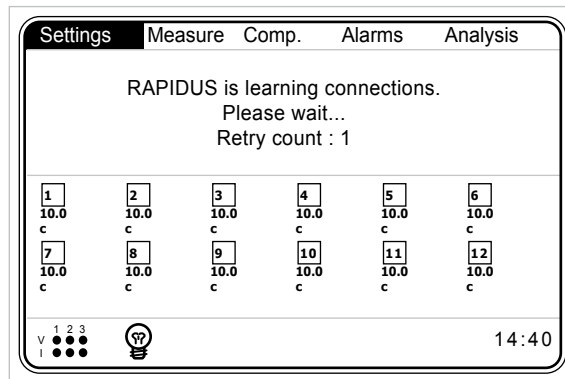

Fig. 3-10 Startup Screen when the Connections Are Being Learned

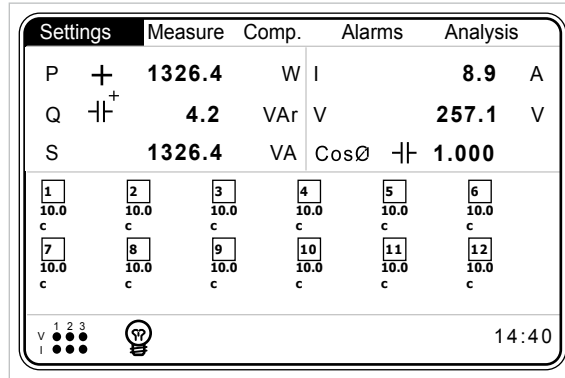

Fig. 3-11 Startup Screen after the Connections Are Learned

Multi selection menus are displayed on the upper part of the screen.

User may navigate on the menus on the upper side of the screen using left and right arrow keys, and access the contents of the menus by pressing OK.

3.2.1 Settings

RAPIDUS settings are made from this menu. If you press OK when the settings tab is highlighted, sub-menus shall be displayed as shown in Fig. 3-12. Sub-menus below are available under the settings tab.

- Quick setup
- Setup
- Date/Time
- System info
- Password
- Restart
- Default Settings

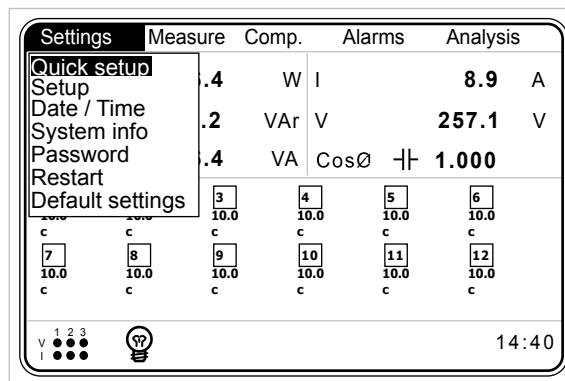

Fig. 3-12 Settings Menu



3.2.1.1 Quick setup Menu

Sub-menus below are available under the quick setup tab:

- Dil / Lang. / Язык
- Date
- Time
- CTR
- VTR
- Step number

Settings->Quick setup	
Dil / Language	English
Date	30 August 2013
Time	21:24:13
CTR	1
VTR	1.0
Step number	1

Fig. 3-13 Quick Setup Menu

3.2.1.1.1 Language Setting

Language is selected in this tab ([See 3.1.1](#)).

3.2.1.1.2 Date Menu

Date setting is performed here ([See 3.1.2](#)).

3.2.1.1.3 Time Menu

Time setting is performed here ([See 3.1.3](#)).

3.2.1.1.4 CTR

Current transformer ratio is entered here ([See 3.1.4](#)).

3.2.1.1.5 VTR

Voltage transformer ratio is entered here ([See 3.1.5](#)).

3.2.1.1.6 Step number

RAPIDUS activates a 3-phase capacitor when it learns the connections. You shall enter the 3-phase capacitor number to be used for learning the connections in this menu.

In order to store the new settings in the nonvolatile memory, you shall return back to the "Startup Screen" from the tab where the changes are made using X key. Press OK when "Settings changed. Save?" message is displayed on the Screen. Thus, the changes are saved and stored in the nonvolatile memory. The changes shall not be saved and stored in the nonvolatile memory if X key is pressed.

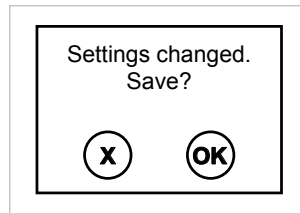

Fig. 3-14 RAPIDUS Prompt for saving



Changes shall be saved on the nonvolatile memory if you press OK when "Settings changed. Save?" message is displayed on the Screen. The changes shall not be saved and stored in the nonvolatile memory if X key is pressed.

3.2.1.2 Setup Menu

Sub-menus below are available under the setup tab:

- Network
- Step
- Compensation
- Learning
- Aux. input
- Device
- Energy
- Communication
- Alarm
- Clear

User may navigate inside the menu using up and down arrow keys, and access the contents of the menus (sub-menus under the setup menu) by pressing OK.

3.2.1.2.1 Network Menu

This menu is used for performing the network settings.

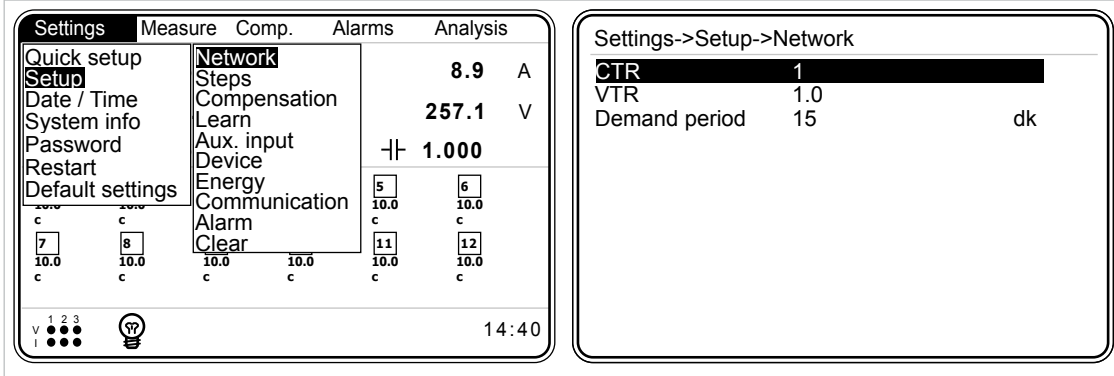

Fig. 3-15 Network Menu

3.2.1.2.1.1 CTR Setting

This is the settings tab for entering the current transformer ratio. Current transformer ratio may be selected between 1 and 5000. (For the usage of RAPIDUS Virtual Keyboard, Refer to 3.1.4 Ex.)

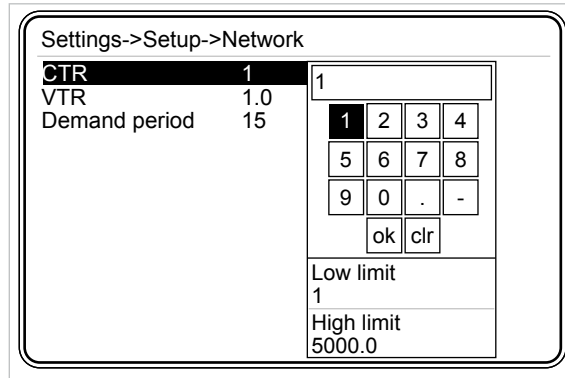

Fig. 3-16 Current Transformer Ratio Setting



Current transformer ratio shall be entered correctly to ensure that RAPIDUS performs a correct measurement.

3.2.1.2.1.2 VTR Setting

This is the settings tab for entering the voltage transformer ratio. Voltage transformer ratio may be selected between 1.0 and 5000.0. (For the usage of RAPIDUS Virtual Keyboard, Refer to 3.1.4 Ex.) If you will enter a number with a decimal place for voltage transformer ratio, select the box on the Virtual Keyboard with arrow keys and press OK.



Voltage transformer ratio shall be entered correctly to ensure that RAPIDUS performs a correct measurement.

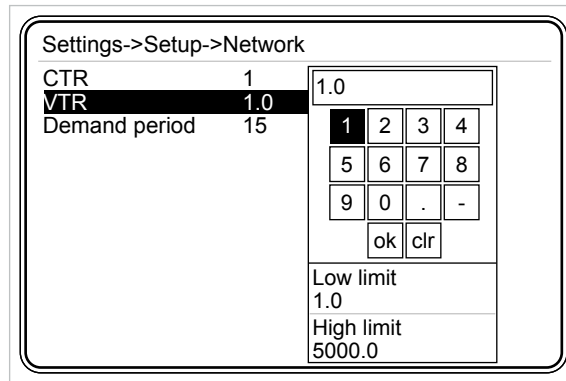

Fig. 3-17 Voltage Transformer Ratio Setting

3.2.1.2.1.3 Demand period setting

This is the settings tab for entering the demand period. Demand period may be selected between 1 and 60 minutes. (For the usage of RAPIDUS Virtual Keyboard, Refer to 3.1.4 Ex.)

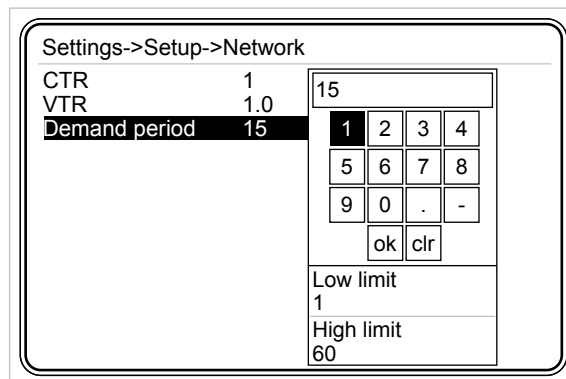
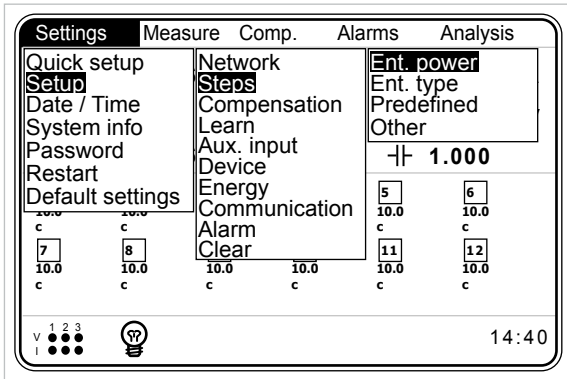

Fig. 3-18 Demand Period Setting

3.2.1.2.2 Step Menu

This menu includes the sub-menus below:

- Ent. power
- Ent. type
- Predefined
- Other



NOTE: There are two Ent. Power sub menus for RAPIDUS 232R-E. Operator can assign 1st, 2nd, ... and 12th step powers in "Ent. Power 1" Submenu. Operator can assign 13th, 14th, ...and 24th step powers in "Ent. Power 1" Submenu.

Fig. 3-19 Step Menu

3.2.1.2.2.1 Ent. Power Menu

Step powers learned by RAPIDUS are indicated in this menu. Also, user may enter/change all step powers manually using this menu.

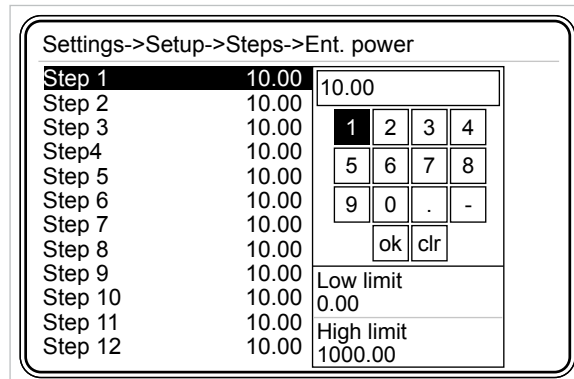

Fig. 3-20 Ent. Power Menu

3.2.1.2.2.2 Ent. Type Menu

Step types learned by RAPIDUS are indicated or user may set the step powers in this menu.

- "C" is for 3-phase capacitor,
- "C1" is for single-phase capacitor connected to R phase,
- "C2" is for single-phase capacitor connected to S phase,

- "C3" is for single-phase capacitor connected to T phase,
- "L" is for 3-phase shunt reactor,
- "L1" is for single-phase shunt reactor connected to R phase,
- "L2" is for single-phase shunt reactor connected to S phase,
- "L3" is for single-phase shunt reactor connected to T phase,
- "C1-2" is for two-phase capacitor connected to R and S "phases (RAPIDUS 232R-E doesn't support)"
- "C2-3" is for two-phase capacitor connected to S and T "phases (RAPIDUS 232R-E doesn't support)"
- "C3-1" is for two-phase capacitor connected to R and T "phases (RAPIDUS 232R-E doesn't support)",



You shall check whether RAPIDUS has learned step types correctly from this menu. If RAPIDUS has not learned step types correctly, perform one of the following.

- RAPIDUS is commanded to learn the steps again (See 3.2.3.6 Learn Steps Menu)
- Step types are corrected manually. (See Fig. 3-21)

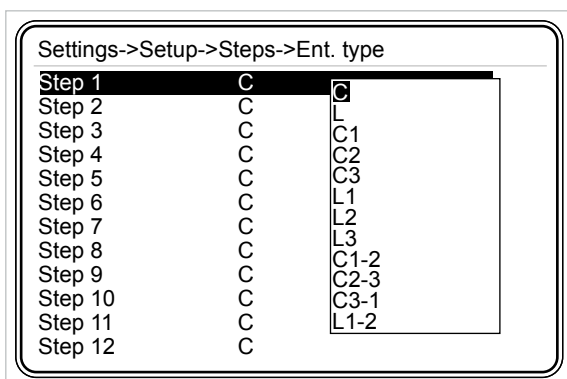

NOTE: There are two "Ent. Type" submenus for RAPIDUS 232R-E. Operator can assign 1st, 2nd, ... and 12th step powers in "Ent. Type 1" Submenu. Operator can assign 13th, 14th, ...and 24th step powers in "Ent. Type 2" Submenu.

Fig. 3-21 Ent. Type Menu

3.2.1.2.2.3 Predefined Menu

Step settings may be performed as per a predefined structure. Relevant settings are performed on the following three sub-menus specified below for predefined menu.

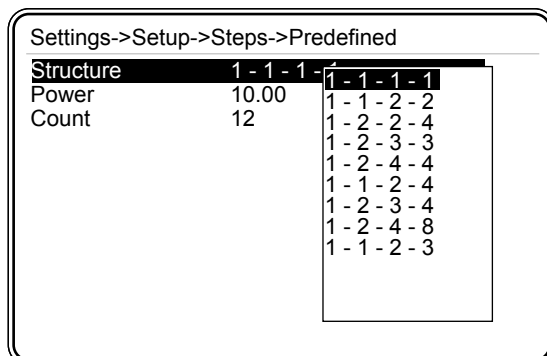

Fig. 3-22 Predefined Menu



3.2.1.2.2.3.1 Structure Menu

Following options are available on the step structure

- 1.1.1.1.1.1.....
- 1.1.2.2.2.2.....
- 1.2.2.4.4.4.....
- 1.2.3.3.3.3.....
- 1.2.4.4.4.4.....
- 1.1.2.4.4.4.....
- 1.2.3.4.4.4.....
- 1.2.4.8.8.8.....
- 1.1.2.3.3.3.....

3.2.1.2.2.3.2 Power Menu

Power of the first step is entered in kVAR. RAPIDUS calculates the step powers after the first step as per the selected template selected in the structure menu.

3.2.1.2.2.3.3 Number Menu

Number of steps in the template selected in structure is set in this menu.

Example:

Assume that 1.2.4.8 is selected as the structure, and 10 kVAR is entered as the power (RAPIDUS takes this value as the 1st step power), and 8 is entered as the number. Then, step powers shall be as follows:

- 1st step: 10 kVAR
- 2nd step: 20 kVAR
- 3rd step: 40 kVAR
- 4th step: 80 kVAR
- 5th step: 80 kVAR
- 6th step: 80 kVAR
- 7th step: 80 kVAR
- 8th step: 80 kVAR

3.2.1.2.2.4 Other Menu

Discharge time is entered here. RAPIDUS waits for the discharge time before reactivating a step that it has deactivated.

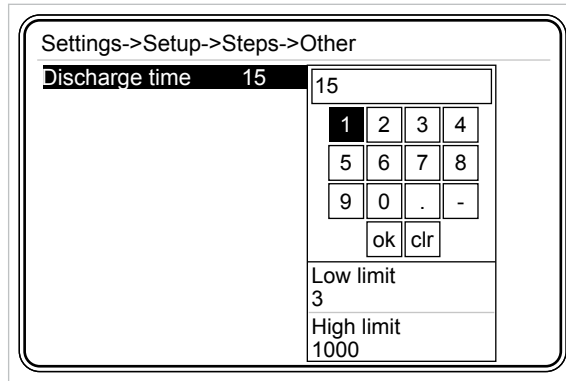

Fig. 3-23 Other Menu

3.2.1.2.3 Compensation Menu

Compensation menu is composed of the tabs shown in Fig. 3-24.

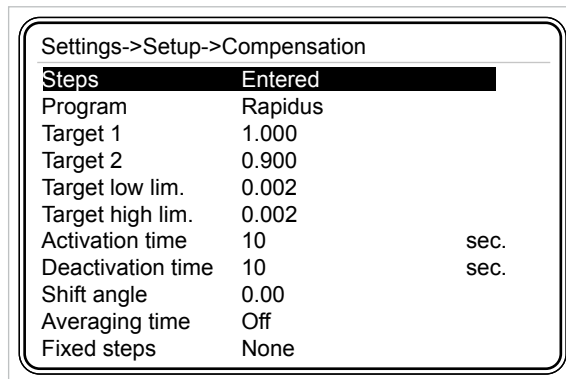

Fig. 3-24 Compensation Menu

3.2.1.2.3.1 Steps Menu

RAPIDUS activates and deactivates steps when it performs reactive power compensation. Step types and power values are determined with 3 different methods.

Entered:

User has entered step values manually to RAPIDUS (See [3.2.1.2.2.1 Ent. Power Menu](#)). RAPIDUS uses these values if "Entered" is selected.

Predefined:

User has entered the step power as described in predefined menu (See [3.2.1.2.2.3 Predefined](#)). RAPIDUS uses these values if "Predefined" is selected.

DCM (Dynamic Capacitor Monitoring):

RAPIDUS follows the step values dynamically. DCM algorithm runs on the background continuously.

When user selects “DCM” option on the “Steps” tab, RAPIDUS uses the step values that it dynamically monitors and updates for compensation.

NOT: DCM(Dynamic Capacitor Monitoring) feature isn't available in for RAPIDUS 232R-E optional model.

3.2.1.2.3.2 Program Menu

RAPIDUS has compensate with 6 different programs.

Rapidus Asc. Sequential, Des. Sequential, Linear and Circular options are programs with their own algorithms.

In the manual option, operator may activate and deactivate any step; RAPIDUS does nothing more than allowing manual access to the operator in this program.

Following features are available in all compensation programs other than “Manual”:

- User may enter any type (capacitor or shunt reactor) and order of steps to RAPIDUS:
- RAPIDUS does not use (ignores) the steps that it has learned as “0” or that is entered by the user as “0”.
- When it has learned a single- or two-phase step, if at least one step is entered as single- or two-phase by the user, RAPIDUS automatically runs on the “Rapidus” compensation program.

Settings->Setup->Compensation		
Steps	Entered	Rapidus
Program	Rapidus	Asc. sequential Des. sequential Linear Circular Manual
Target 1	1.000	
Target 2	0.900	
Target low lim.	0.002	
Target high lim.	0.002	
Activation time	10	sec.
Deactivation time	10	sec.
Shift angle	0.00	
Averaging time	Off	
Fixed steps	None	

Fig. 3-25 Program Menu



3.2.1.2.3.2.1 Rapidus Program



“Rapidus” option is the only compensation program that allows single- or two-phase capacitors and/or single- or two-phase shunt reactor (other than “Manual”)

The compensation program selected in the default settings (factory settings) of RAPIDUS is the “Rapidus” option. It activates the step combination closest to the measured demand.

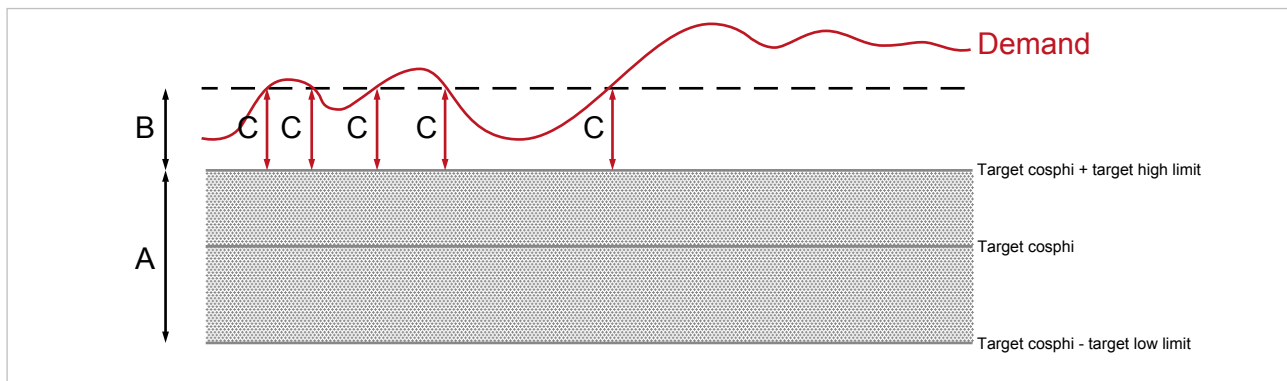

Fig. 3-26 RAPIDUS Mode Compensation Steps

On the diagram above:

A: Reactive power interval corresponding to the measured $\text{Cos}\phi$ values.

B: Limit value decided for compensation by RAPIDUS (calculated as per automatic C/K ratio).

C: Reactive power value to be compensated.

When the system is in interval A, RAPIDUS does not compensate. When the system is in this interval, activation and deactivation counters of RAPIDUS are not active.

RAPIDUS starts to activate a step after an “activation time” (See 3.2.1.2.3.7 Activation time) when the system reactive power requirement reaches over B point.

Similarly, RAPIDUS starts to deactivate a step after a “deactivation time” (See 3.2.1.2.3.8 Deactivation time) when the system reactive power requirement is decreased under B point.

3.2.1.2.3.2.2 Ascending Sequential program



All steps (capacitor or reactor) shall have 3 phases in ascending sequential program.

Step activation and deactivation operations are performed by starting from the step with the lowest power (ascending sequential). When activation/deactivation is required, only one step is activated/deactivated. Then reactive power is calculated again. If activation/

deactivation demand is continued, next step with the lowest power is activated/deactivated.

• **When the System is Inductive**

If a shunt reactor is activated, RAPIDUS deactivates steps one by one until the demand is met starting with the shunt reactor with the lowest power.

Assume all shunt reactors are deactivated and system is still inductive. RAPIDUS activates steps starting with the capacitor step with the lowest power.

• **When the System is Capacitive**

If a capacitor is activated, RAPIDUS deactivates all steps one by one until the demand is met starting with the capacitor with the lowest power.

Assume all capacitors are deactivated and system is still capacitive. RAPIDUS activates steps starting with the shunt reactor step with the lowest power.

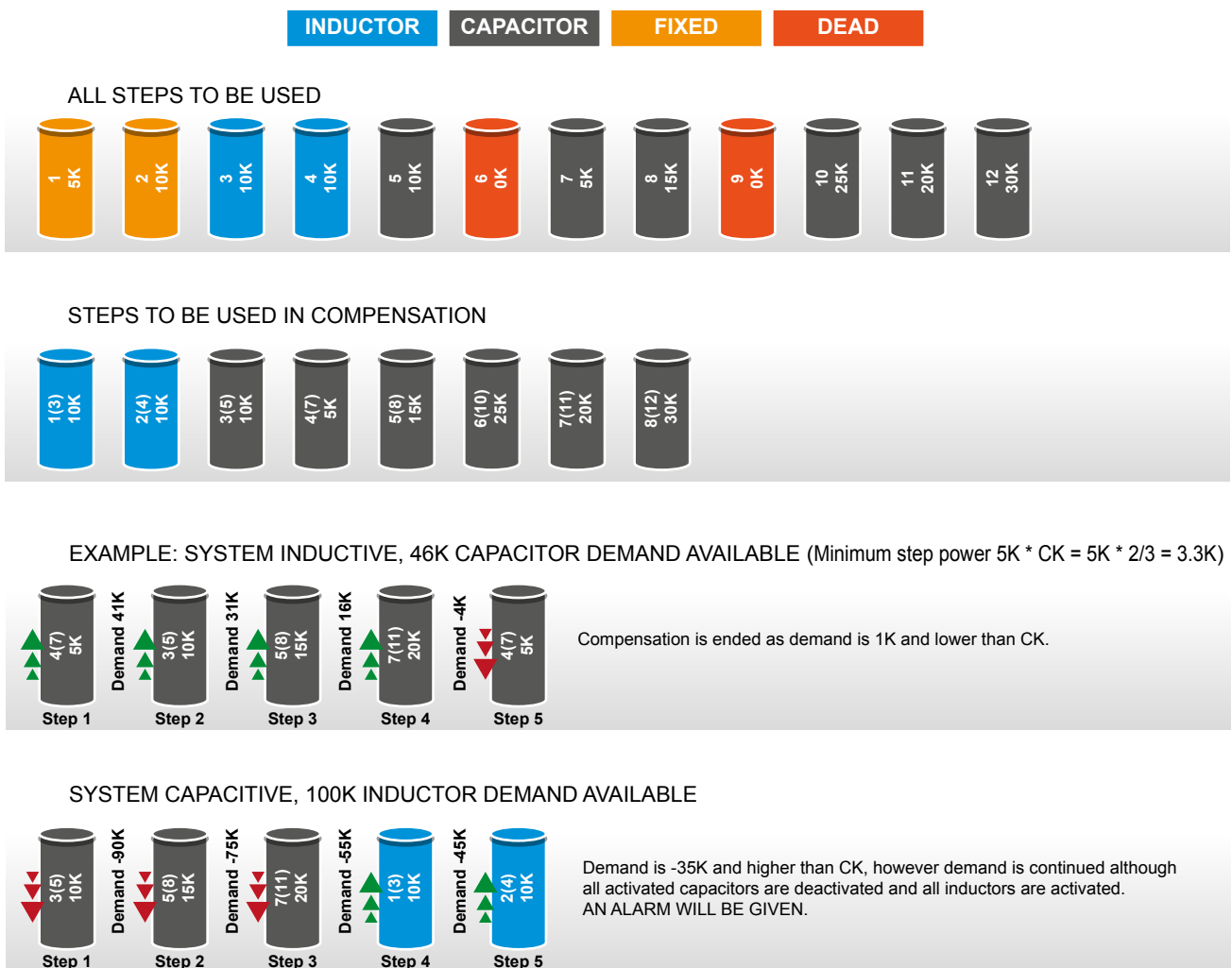

Fig. 3-27 RAPIDUS Asc. Sequential Mode



3.2.1.2.3.2.3 Descending Sequential Mode



All steps (capacitor or reactor) shall have 3 phases in descending sequential program.

RAPIDUS performs activation/deactivation operation starting with the step closest to the demand. When activation/deactivation is required, only one step is activated/deactivated. Then reactive power is calculated again. If activation/deactivation demand is continued, next step closest to the demand is activated/deactivated.

- **If the System is Inductive:**

If a shunt reactor is activated, steps are deactivated one by one until the demand is met starting with the shunt reactor closest to the demand.

If system is still inductive although all shunt reactors are deactivated, and there are capacitor steps that are not active, steps are activated one by one until the demand is met starting with the capacitor step closest to the demand.

- **If the System is Capacitive:**

If a capacitor is activated, steps are deactivated one by one until the demand is met starting with the capacitor closest to the demand.

If system is still capacitive although all capacitors are deactivated, and there are shunt reactor steps that are not active, steps are activated one by one until the demand is met starting with the shunt reactor step closest to the demand.

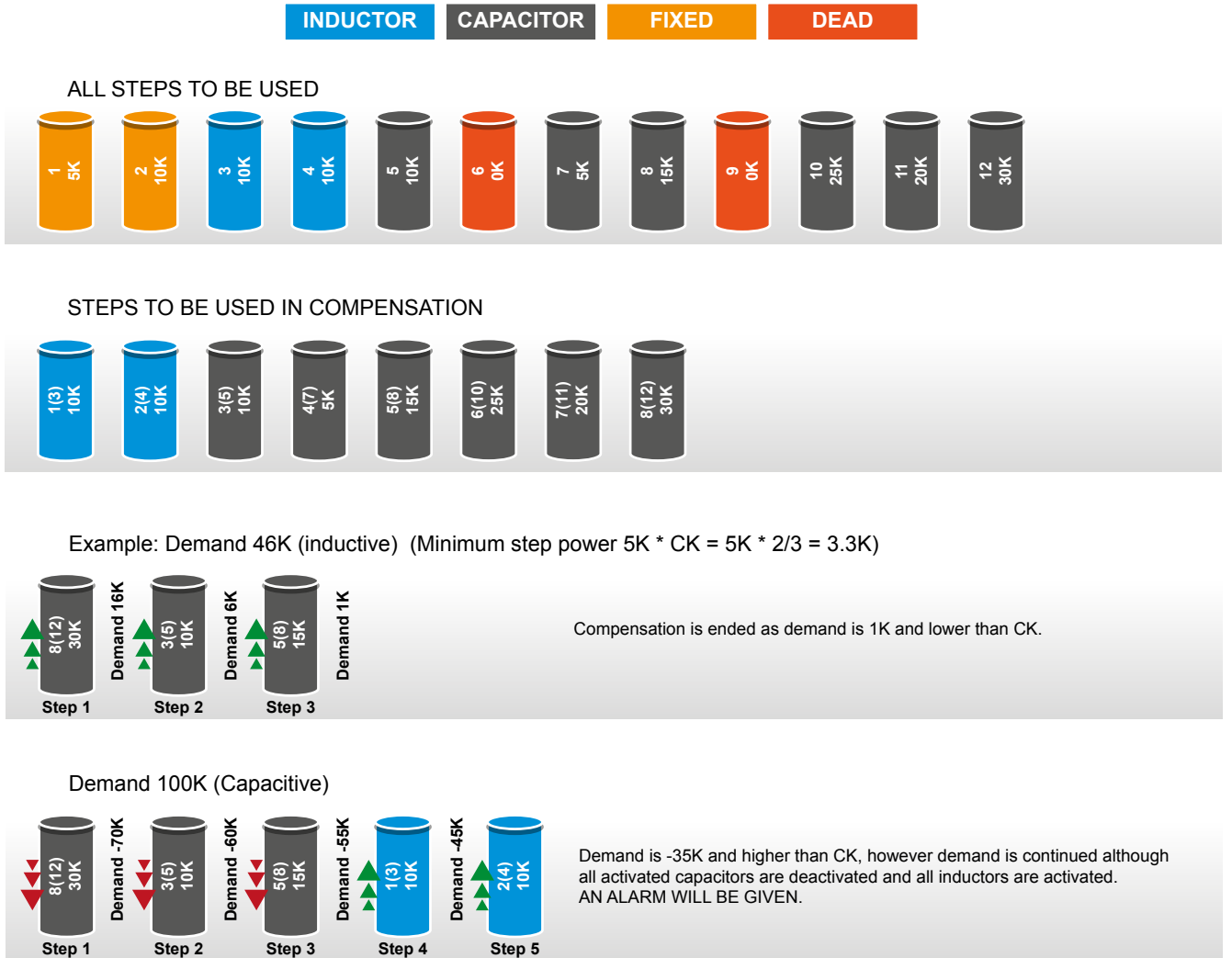

Fig. 3-28 RAPIDUS Des. Sequential Mode



3.2.1.2.3.2.4 Linear Mode



All steps (capacitor or reactor) shall have 3 phases in linear program.



Linear program is used in panels with the step structure 1.1.1.1.

The step activated first is deactivated last in linear program.

- **If the System is Inductive:**

If there are shunt reactors activated, the number of shunt reactors that will the demand shall be deactivated. If the system is still inductive although all shunt reactors are deactivated, the number of capacitors required shall be activated.

- **If the System is Capacitive:**

If there are capacitors activated, the number of capacitors that will the demand shall be deactivated. If the system is still capacitive although all capacitors are deactivated, the number of shunt reactors required shall be activated.

INDUCTOR

CAPACITOR

FIXED

DEAD

ALL STEPS TO BE USED

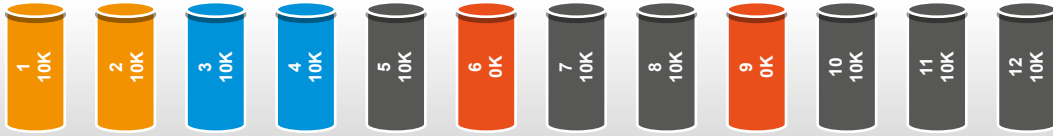

STEPS TO BE USED IN COMPENSATION

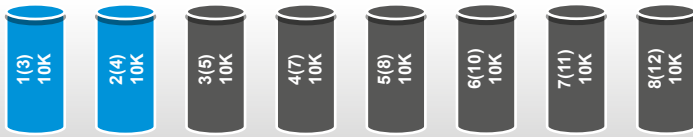

Example: SYSTEM INDUCTIVE, 46K CAPACITOR DEMAND AVAILABLE (Minimum step power $10K * CK = 10K * 2/3 = 6.7K$)

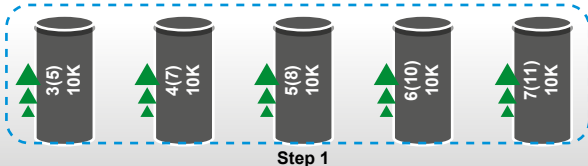

Compensation is ended as demand is -4K and lower than CK.

SYSTEM CAPACITIVE, 20K INDUCTOR DEMAND AVAILABLE

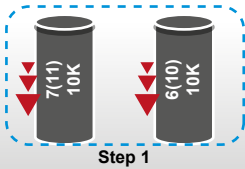

Compensation is ended as demand is 0K and lower than CK.

SYSTEM CAPACITIVE, 40K INDUCTOR DEMAND AVAILABLE

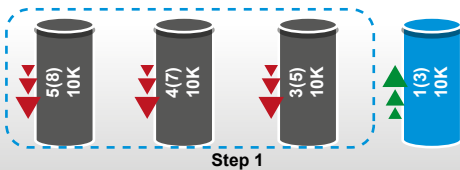

Compensation is ended as demand is 0K and lower than CK.

SYSTEM CAPACITIVE, 20K INDUCTOR DEMAND AVAILABLE



Compensation Demand is continued as demand is -10K and higher than CK. However, there are no inductors to activate nor capacitors to deactivate. AN ALARM WILL BE GIVEN.

Fig. 3-29 RAPIDUS Linear Mode



3.2.1.2.3.2.5 Circular Mode



All steps (capacitor or reactor) shall have 3 phases in circular program.



Circular program is used in panels with the step structure 1.1.1.1.

The step activated first is deactivated first in circular program.

- **If the system is inductive:**

If there are shunt reactors activated, the number of shunt reactors that will the demand shall be deactivated. If the system is still inductive although all shunt reactors are deactivated, the number of capacitors required shall be activated.

- **If the system is capacitive:**

If there are capacitors activated, the number of capacitors that will the demand shall be deactivated. If the demand is resumed although all capacitors are deactivated, the number of shunt reactors required shall be activated.

INDUCTOR CAPACITOR FIXED DEAD

ALL STEPS TO BE USED

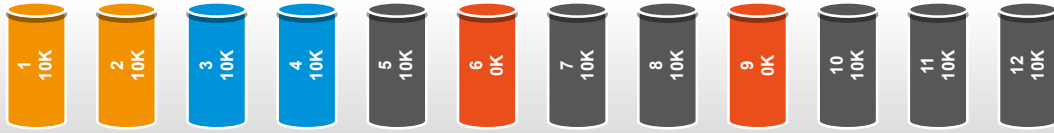

STEPS TO BE USED IN COMPENSATION

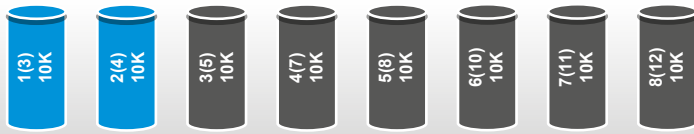

Example: SYSTEM INDUCTIVE, 46K CAPACITOR DEMAND AVAILABLE (Minimum step power $10K * CK = 10K * 2/3 = 6.7K$)

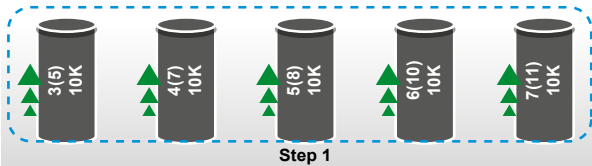

Compensation is ended as demand is -4K and lower than CK.

SYSTEM CAPACITIVE, 30K INDUCTOR DEMAND AVAILABLE

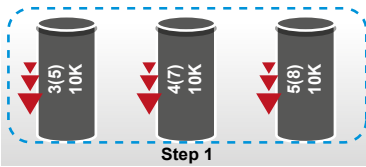

Compensation is ended as demand is 0K and lower than CK.

SYSTEM INDUCTIVE, 20K CAPACITOR DEMAND AVAILABLE

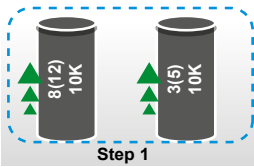

Compensation is ended as demand is 0K and lower than CK.

SYSTEM CAPACITIVE, 60K INDUCTOR DEMAND AVAILABLE

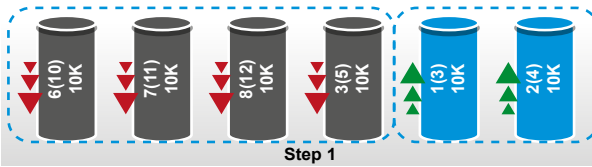

Compensation is ended as demand is 0K and lower than CK.

SYSTEM INDUCTIVE, 90K CAPACITOR DEMAND AVAILABLE

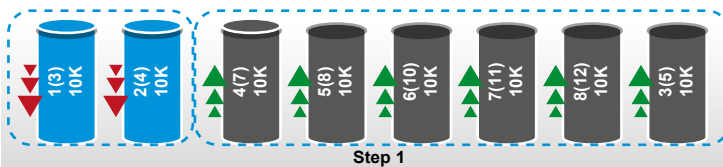

Demand is -10K, however, there are no inductors to activate nor capacitors to deactivate although the demand is continued. AN ALARM WILL BE GIVEN.

Fig. 3-30 RAPIDUS Circular Mode

3.2.1.2.3.2.6 Manual program



RAPIDUS does not perform automatic compensation when it is taken in manual mode.

When manual program is active, a “hand” symbol is displayed on the lower left corner of the main menu page. This symbol indicates that RAPIDUS is in manual compensation mode.

Manual mode is activated by pressing down arrow when you are in main menu screen. The step that shall be activated is highlighted with arrow keys and OK key is pressed. Thus, step shall be activated. Step shall be deactivated when you highlight the step that will be deactivated and press OK. If an hourglass symbol is displayed while the step is being activated, this indicates that discharge time is waited to activate the step.

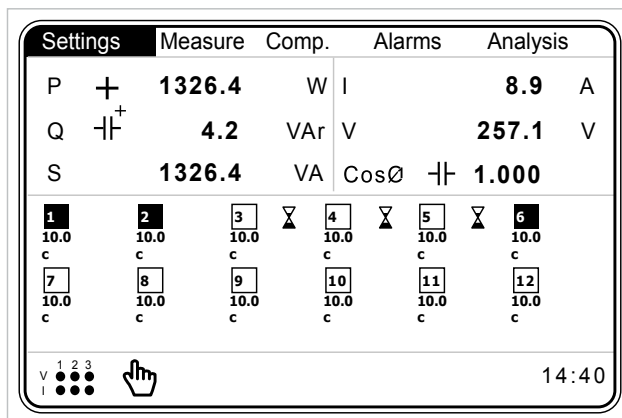

Fig. 3-31 Manual Mode Menu

If operator press down key, below screen is shown.

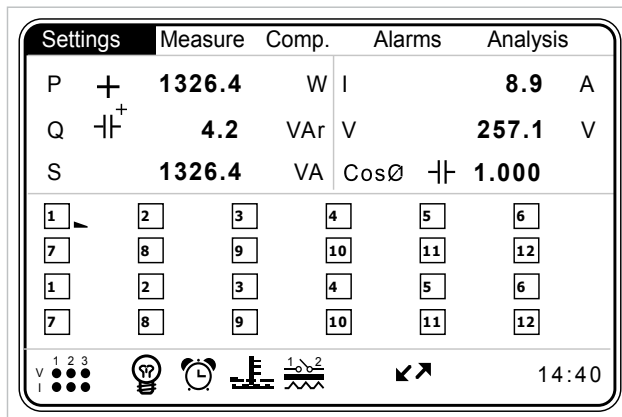

Fig. 3-32 RAPIDUS with 24 RELAYS

Operator can scroll inside steps by pressing right and left keys. When OK key is pressed below screen is shown. If operator press "OK" key again, the related step will be activated. The "v" symbol indicates the related relay is activated.





Settings	Measure	Comp.	Alarms	Analysis
P +	1326.4	W I		8.9 A
Q - +	4.2	VAr	V	257.1 V
S	1326.4	VA	CosØ - +	1.000
Number 1 Type C ✓ Power 10.00kVAr Switch 0 Time 0				
V I 1 2 3      14:40				

Fig. 3-33 Step Information Screen for RAPIDUS 232R-E

3.2.1.2.3.3 Target 1 Menu

Target 1 CosΦ value is set here. It can be set between -0.800 and 0.800. Negative value indicates capacitive target, positive value indicates inductive target.

3.2.1.2.3.4 Target 2 Menu

Target 2 CosΦ value is set here. It can be set between 0.800 and 1.000. Positive value indicates inductive target.

For this feature to be active:

- Operator should change Mod tab of "Settings->Setup->Aux. input" setting to either of the following
Night/day
Generator
- GEN input should be activated with 85-265VAC.

3.2.1.2.3.5 Target Low Lim. Menu

It is the lower tolerance value for target 1 and target 2 settings. It can be set between 0.000 and 0.200.

3.2.1.2.3.6 Target High Lim. Menu

It is the upper tolerance value for target 1 and target 2 settings. It can be set between 0.000 and 0.200.



3.2.1.2.3.7 Activation Time Menu

RAPIDUS waits for the “activation time” before activating a step. Activation time may be selected between 1 and 600 seconds.

3.2.1.2.3.8 Deactivation Time Menu

RAPIDUS waits for the “deactivation time” before deactivating a step. Deactivation time may be selected between 1 and 600 seconds.

3.2.1.2.3.9 Shift Angle Menu

By entering the shift angle, changes in reactive power (transformer losses) that occur before the RAPIDUS measurement point are compensated.

Shift angle is set from -45° to 45° . RAPIDUS adds the reactive power that is calculated with the shift angle to the reactive power that it calculates by measuring the system voltage and current. Then it calculates the $\cos\phi$ value and compensates.

Index values vary as per shift angle.

Example 1:

Assume that the $\cos\phi$ value indicated by RAPIDUS is 1.000.

When the user enters 20° as the shift angle, RAPIDUS shall calculate $\cos\phi$ value as 0.940 inductive.

When the user enters -30° as the shift angle, RAPIDUS shall calculate $\cos\phi$ value as 0.866 capacitive.



3.2.1.2.3.10 Averaging Time

After accomplishing its measurements, RAPIDUS can quickly decide whether there is a need to switch in or out step(s). In summary, RAPIDUS is a quick responding reactive power controller.

If the operator does not require RAPIDUS to respond quickly, operator should adjust the device via this tab.

RAPIDUS takes average of the measured power during the adjusted interval (5 sec. – 60 sec.). Just after the adjusted time interval elapses, RAPIDUS compensates according to the calculated average power.

This setting will increase response time of RAPIDUS. However, on the other side, this setting will lengthen the lifetime of switch gear of the system. This is a compromise of opposite requirements, and it changes from system to system.”

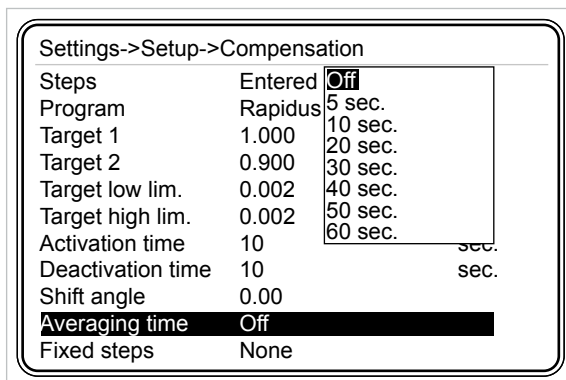

Fig. 3-34 Averaging Time Menu

3.2.1.2.3.11 Fixed Steps Menu

First three steps of RAPIDUS may be assigned as fixed steps. On the main menu screen, “↓” symbol is displayed next to the step assigned as fixed symbol.

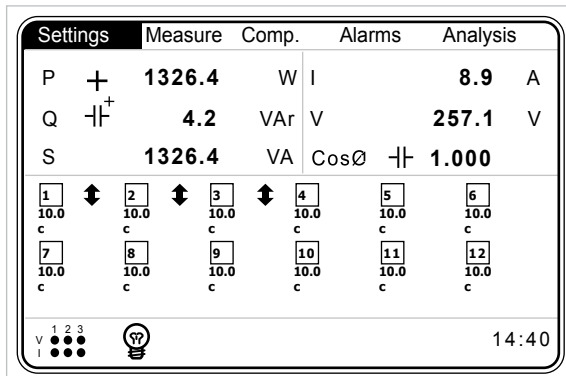

Fig. 3-35 Fixed Steps Menu

3.2.1.2.4 Learn Menu

Settings for learning of steps and connections by RAPIDUS are performed from this menu.



3.2.1.2.4.1 Learn Conn. Menu

Settings for learning of current and voltage connections by RAPIDUS are performed here.

3.2.1.2.4.1.1 Learn at start

On => RAPIDUS learns connections automatically when it is turned on or restarted.

Off => RAPIDUS does not learn connections automatically when it is turned on or restarted.



If it is used as "On", connections are learned again and again when Rapidus is restarted or powered on. After connections are learned by Rapidus, it is highly recommended to use this setting as "Off". Otherwise connection can be learned wrongly.

Besides, factory setting is "Off" as well.

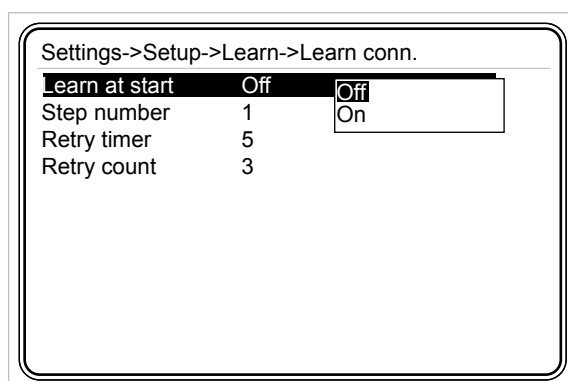

Fig. 3-36 Connection Setup

If the connections shall not be learned at start up, we advise them to be learned manually. This procedure is performed at "Compensation->Learn conn." menu. (See [3.2.3.4 Learn Conn. Menu](#))

Factory setting for connections is V1, V2, V3, I1, I2 and I3. RAPIDUS shall take a measurement with this combination in the initial start.



In cases where electrical system is unbalanced and/or there are sudden load changes, "learn algorithm" can be completed in an erroneous result. In such a situation, active powers measured by Rapidus will also be positive (checking active powers will not help).

Therefore, it is important that operator should also physically check connections.

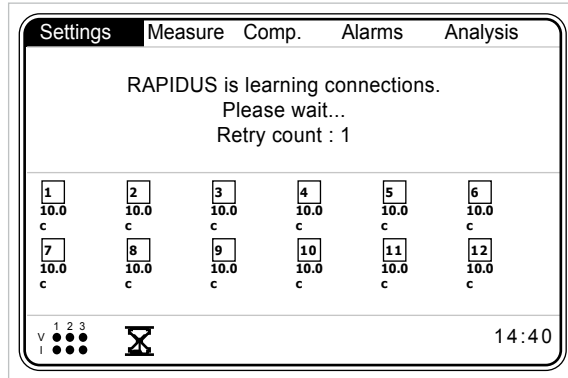

Fig. 3-37 Learning Connections at the Startup

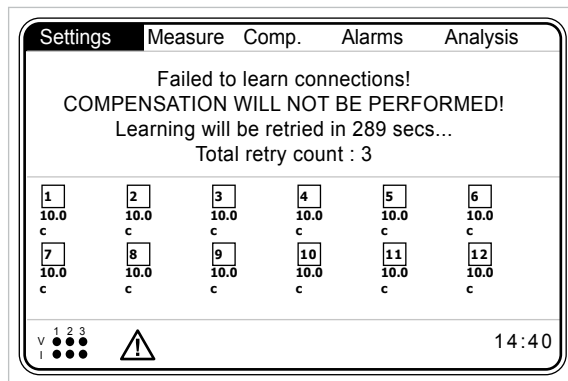

Fig. 3-38 Waiting Time After Unsuccessful Connection Learning

3.2.1.2.4.1.2 Step number

RAPIDUS learns the connections by activating a 3-phase capacitor.

We advise you to enter the step number that the capacitor with the highest power value is connected.



If the number of a step that is determined as faulty by RAPIDUS is entered to “Step number” setting, an error/warning message shall be displayed on the screen.

3.2.1.2.4.1.3 Retry Timer

If RAPIDUS could not learn the connection after making retries equal to the “Retry number”, it waits for the set retry timer without compensating. Then (after the “Retry timer”), it tries to learn the connections. This cycle is continued until the connections are learned.

While waiting for the “Retry timer”, RAPIDUS continues to make measurements and display these measurements on its screen, but it does not compensate.

If user does not want to wait during the retry timer, he/she can manually command from "Comp.->Learn conn.":

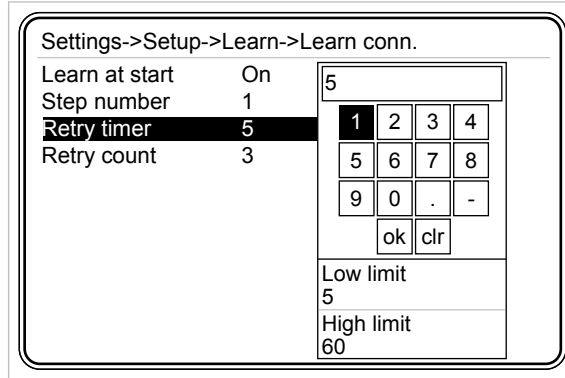

Fig. 3-39 Retry Timer

3.2.1.2.4.1.4 Retry Number

When it cannot learn the connection at startup, RAPIDUS it tries to learn the connections for times equal to the "Retry Number".

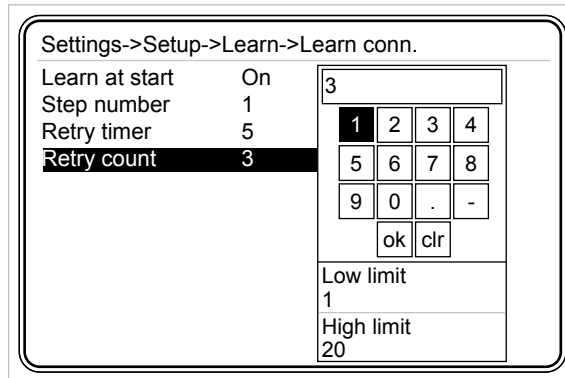

Fig. 3-40 Retry Count

3.2.1.2.4.2 Learn Step Menu

Settings for learning of current and voltage connections by RAPIDUS are performed here.

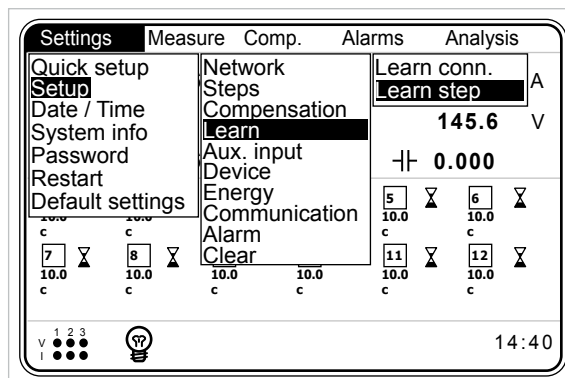

Fig. 3-41 Learn step

3.2.1.2.4.2.1 Learn at start

On => RAPIDUS learns step powers automatically when it is turned on or restarted.

Off => RAPIDUS does not learn step powers automatically when it is turned on or restarted.



If it is used as "On", step powers are learned again and again when Rapidus is restarted or powered on. After step powers are learned by Rapidus, it is highly recommended to use this setting as "Off". Otherwise step powers can be learned wrongly.

Besides, factory setting is "Off" as well.

3.2.1.2.4.3 Aux. Input Menu

Aux. input menu is used to ensure that, RAPIDUS compensates as per the secondary target $\cos\phi$.

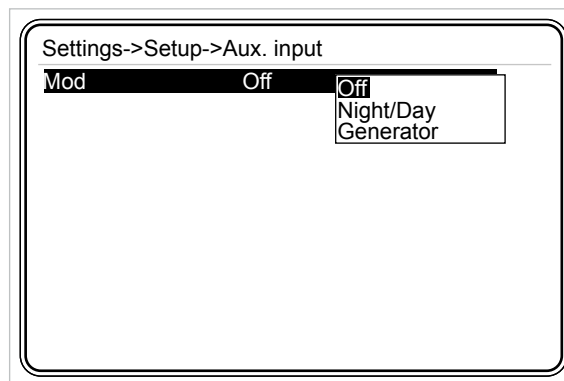

Fig. 3-42 Aux. Input

3.2.1.2.4.4 Off mode

If the digital input mode is selected as "Off", GEN input shall not affect running of RAPIDUS. RAPIDUS compensates as per "Target 1 value."

3.2.1.2.4.5 Night/Day Mode

If aux. input mode is selected as "Night/Day", compensation is performed as per "Target 2 value" when GEN input is active. Energy menu counters count independent of the GEN input.

3.2.1.2.4.6 Generator Mode

If aux. input mode is selected as “Generator”, compensation is performed as per the set “Target 2 value” when GEN input is active. Then, energy menu counters (See 3.2.2.2 Energy Menu) do not count.

3.2.1.2.5 Device Menu

This menu is used for performing the following settings.

- Language
- Contrast
- Pass. protection
- New password
- Display on
- Display on time

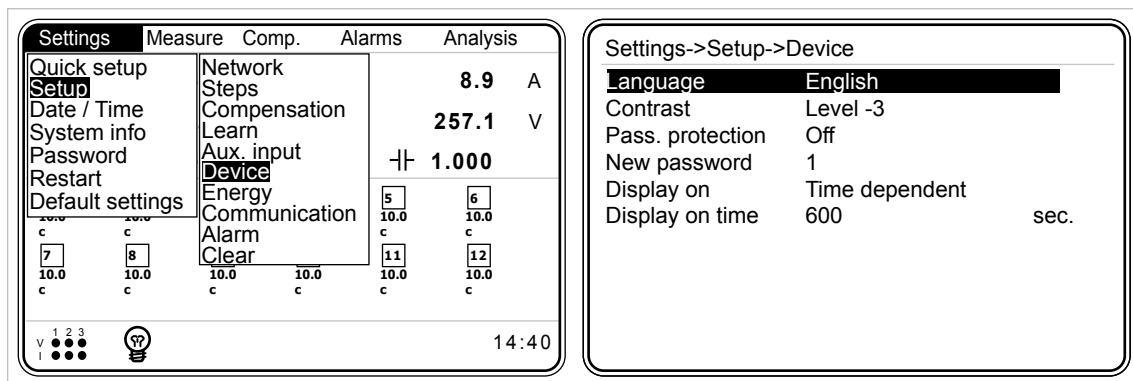

Fig. 3-43 Device Menu

3.2.1.2.5.1 Language Setting

- Türkçe
- English
- Русский

User shall select the desired setting with up and down arrows and press "OK".

3.2.1.2.5.2 Contrast Setting

This menu is used for performing the contrast setting. Level setting steps are displayed when you press OK when this option selected. User shall select the desired contrast level with up and down arrows and press "OK". RAPIDUS screen gets darker when you go up to level 4. RAPIDUS screen gets lighter when you go down to level -4.

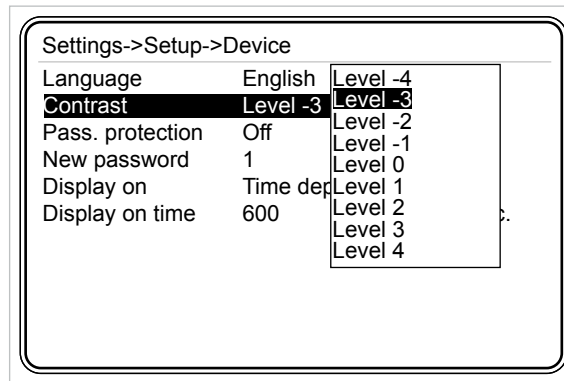

Fig. 3-44 Contrast Setting

3.2.1.2.5.3 Pass. Protection

If password protection is selected as "On", you shall enter a password in order to enter the setting menus each time RAPIDUS is restarted again.

If password protection is selected as "Off", you do not need to enter a password in order to enter the setting menus each time RAPIDUS is restarted again.

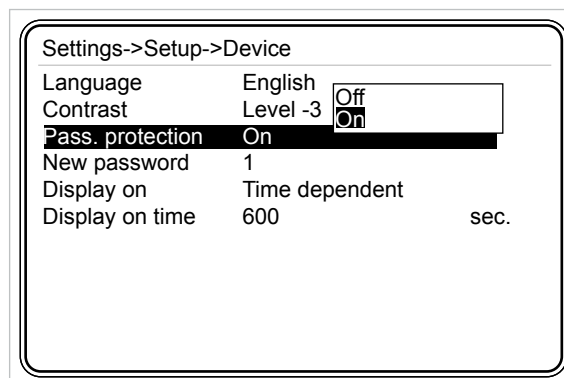

Fig. 3-45 Pass. Protection

3.2.1.2.5.4 New Password Setting

Factory set password of RAPIDUS is "1". New password may be selected between 1 and 9999. (For the usage of RAPIDUS Virtual Keyboard, Refer to 3.1.4 Ex.)

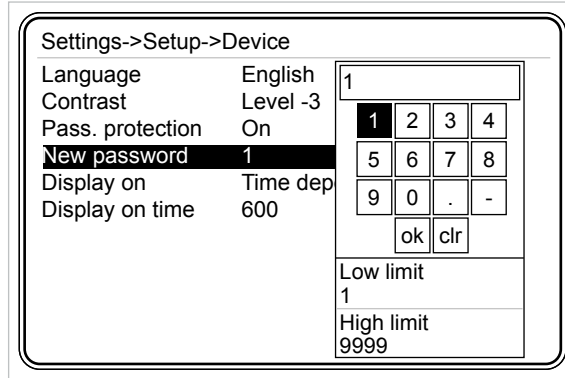

Fig. 3-46 New Password Entry

3.2.1.2.5.5 Display On Setting

- Continuous
- Time dependent

When continuous is selected, the backlight of RAPIDUS display does not turn off. When time dependent is selected, screen backlight is turned on for "display on time".

3.2.1.2.5.6 Display On Time Setting

This tab is used for setting the on time for the backlight of RAPIDUS display. It may be selected between 10 and 600 seconds. (For the usage of RAPIDUS Virtual Keyboard, Refer to 3.1.4 Ex.)

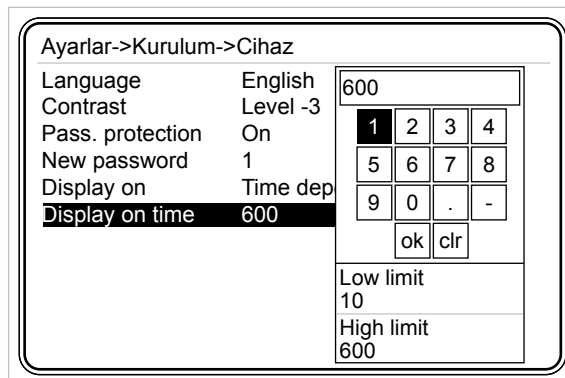

Fig. 3-47 Display On Time Setting



3.2.1.2.6 Energy Menu

This menu is used for entering the initial energy values. The settings in this menu are used for synchronization of system electricity counter and RAPIDUS counters. User shall select the desired energy value with up and down arrows and press "OK".

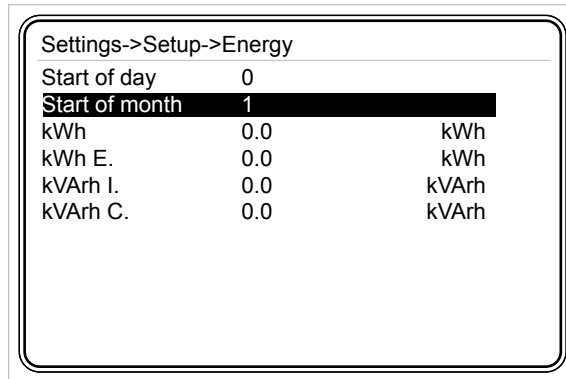

Fig. 3-48 Energy Menu

3.2.1.2.6.1 Start of day setting

This is the settings tab for entering the time for start of the day. Start of the day time may be selected between 0 and 23. (For the usage of RAPIDUS Virtual Keyboard, [Refer to 3.1.4 Ex.](#))

3.2.1.2.6.2 Start of month setting

This is the settings tab for entering the day for start of the month. Start of month day may be selected between 1 and 28. (For the usage of RAPIDUS Virtual Keyboard, [Refer to 3.1.4 Ex.](#))

The settings listed below between 3.2.1.2.6.3 and 3.2.1.2.6.6 are used for synchronization of system electricity counter and RAPIDUS counter. Each of them may be set between 0.0 and 20000000000.0. (For the usage of RAPIDUS Virtual Keyboard, [Refer to 3.1.4 Ex.](#))

3.2.1.2.6.3 kWh Setting

This tab is used for entering the "initial" value for imported active energy.

3.2.1.2.6.4 kWh E. Setting

This tab is used for entering the "initial" value for exported active energy.



3.2.1.2.6.5 kVArh I. Setting

This tab is used for entering the “initial” value for inductive reactive energy.

3.2.1.2.6.6 kVArh C. Setting

This tab is used for entering the “initial” value for capacitive reactive energy.

3.2.1.2.7 Communication Menu

RAPIDUS includes Modbus RTU communication protocol. Settings related with Modbus protocol are made in this menu.

3.2.1.2.7.1 Baud Rate Menu

User shall select the desired value with up and down arrows and press “OK”. RAPIDUS communicates with speeds of 2400, 4800, 9600, 19200, 38400, 57600 and 115200 bit/second.

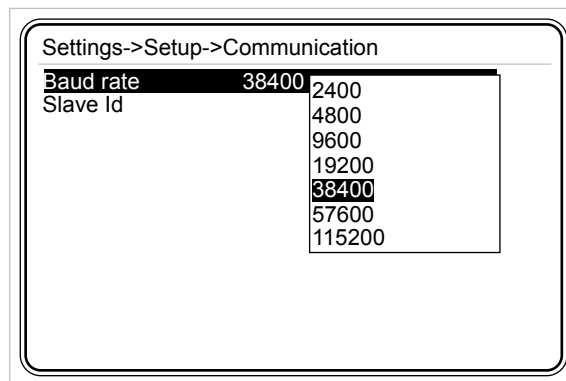

Fig. 3-49 Baud Rate Setting

3.2.1.2.7.2 Slave Id Menu

This is the settings tab for entering the slave id number. (For the usage of RAPIDUS Virtual Keyboard, Refer to 3.1.4 Ex.).

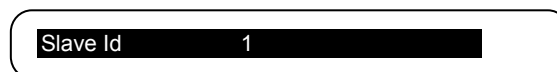

Fig. 3-50 Slave Id Setting

Maximum 247 devices may communicate over the same RS485 line. Therefore, slave id may be selected between 1 and -247.

3.2.1.2.8 Alarm Menu

User may navigate in the alarm settings menu using up and down arrow keys, and access the contents of the sub-menus of alarm menu by pressing OK.

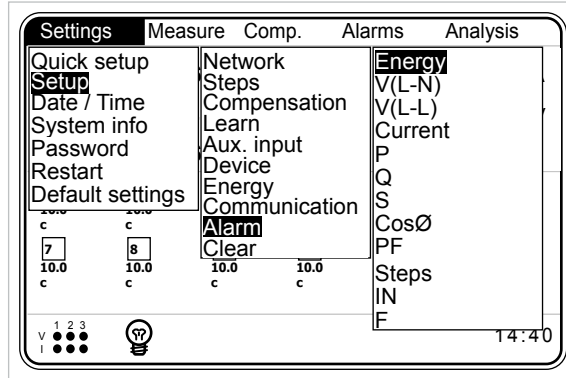

Fig. 3-51 Alarm Menu

3.2.1.2.8.1 Energy Alarm Menu

This menu is used for performing the upper limit alarm settings of Inductive/Active and Capacitive/Active ratios. User may navigate in Energy alarms menu with up and down arrows.

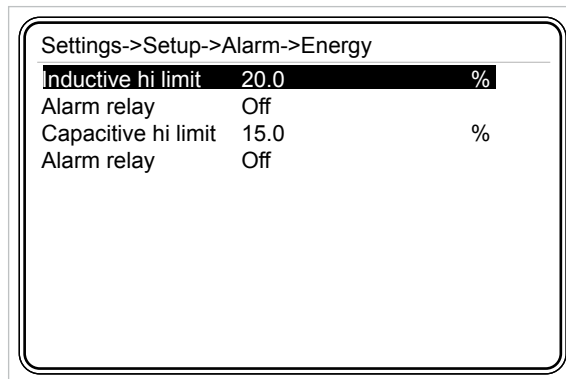

Fig. 3-52 Energy Menu

$$\text{Inductive hi limit} = \frac{\text{Inductive reactive energy}}{\text{Active energy}} \times 100$$

$$\text{Capacitive hi limit} = \frac{\text{Capacitive reactive energy}}{\text{Active energy}} \times 100$$

Refer to descriptions of V(L-N) Alarm menu for the alarm relay setting.



3.2.1.2.8.2 V(L-N) Alarm Menu

This sub-menu is used for phase-neutral voltage alarm settings. User may navigate in V(L-N) alarms menu with up and down arrows.

Settings->Setup->Alarm->V(L-N)		
Alarm relay	Off	
Low limit	0.0	V
High limit	0.0	V
Delay	0	sec.
Hysteresis	0.0	%

Fig. 3-53 V(L-N) Alarm Menu

Alarm relay:

This setting is used for regulation of pulling of the relays when an alarm occurred only. In order to ensure that RAPIDUS gives a V (L-N) alarm, lower and upper limit values shall be set as described below.

Alarm relay options:

Off: No alarm relay is pulled in case of an alarm

Relay1 : Only relay 1 is pulled in case of an alarm

Relay2 : Only relay 2 is pulled in case of an alarm

User shall select the desired setting with up and down arrows and press "OK".

Alarm relay	Off
-------------	-----

Fig. 3-54 Alarm Relay Setting

If V(L-N) in any of three phases goes out of low or high limit, RAPIDUS gives an alarm.

Low Limit:

This tab is used for entering alarm low limit. (For the usage of RAPIDUS Virtual Keyboard, Refer to 3.1.4 Ex.). In order to set an alarm for V (L-N) values, user shall enter a smaller low limit than high limit. If low limit and high limit values entered are the same, V(L-N) parameter is closed for alarms.

High Limit:

This tab is used for entering alarm high limit. (For the usage of RAPIDUS Virtual Keyboard, Refer to 3.1.4 Ex.). In order to set an alarm for V (L-N) values, user shall enter a higher high limit than low limit. If low limit and high limit values entered are the same, V(L-N) parameter is closed for alarms.

Delay:

RAPIDUS waits for the delay time before giving an alarm when the related alarm parameter exceeds “Low limit” or “High limit” value. Also, RAPIDUS waits for the delay time again before cancelling an alarm condition when the related alarm parameter returns back in the limits. It may be selected between 0 and 600 seconds. (For the usage of RAPIDUS Virtual Keyboard, [Refer to 3.1.4 Ex.](#)).



Fig. 3-55 Alarm Time Setting

Hysteresis setting:

This is the tolerance value entered in %. Refer to the example below and Fig. 3-56 for the usage method. It may be selected between 0.0 and 20.0. (For the usage of RAPIDUS Virtual Keyboard, [Refer to 3.1.4 Ex.](#))

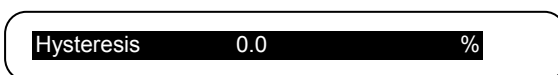

Fig. 3-56 Hysteresis Setting

Example:

For the figure below (delay setting is zero):

- An alarm occurs in point A
- Alarm is cancelled in point B
- An alarm occurs in point C
- Alarm is cancelled in point D

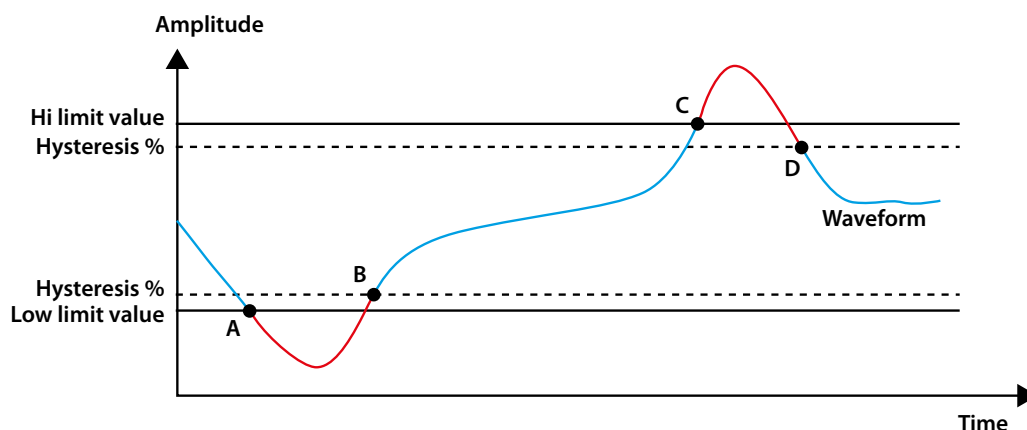

Fig. 3-57 Alarm Example



3.2.1.2.8.3 V(L-L) Alarm Menu

This sub-menu is used for phase-phase voltage alarm settings. Settings are the same for the settings for Alarm->V(L-N) menu. (V(L-L) low and high limit values: 0.0↔2600000.0).

3.2.1.2.8.4 Current Alarm Menu

This sub-menu is used for current alarm settings. Settings are the same for the settings for Alarm->V(L-N) menu. (Current low and high limit values: 0.0↔30000.0)

3.2.1.2.8.5 P Alarm Menu

This sub-menu is used for active power alarm settings. Settings are the same for the settings for Alarm->V(L-N) menu. (P low and high limit values: -10000000000.0↔10000000000.0)

3.2.1.2.8.6 Q Alarm Menu

This sub-menu is used for reactive power alarm settings. Settings are the same for the settings for Alarm->V(L-N) menu. (Q low and high limit values: -10000000000.0↔10000000000.0)

3.2.1.2.8.7 S Alarm Menu

This sub-menu is used for apparent power settings. Settings are the same for the settings for Alarm->V(L-N) menu. (S low and high limit values: 0.0↔10000000000.0)

3.2.1.2.8.8 CosØ Alarm Menu

This sub-menu is used for CosØ alarm settings. Settings are the same for the settings for Alarm->V(L-N) menu. (CosØ low and high limit values: 0.000↔1.000).

3.2.1.2.8.9 PF Alarm Menu

This sub-menu is used for power factor alarm settings. Settings are the same for the settings for Alarm->V(L-N) menu. (PF low and high limit values: 0.000↔1.000)

3.2.1.2.8.10 Step Alarm Menu

This sub-menu is used for step alarm settings. RAPIDUS gives an alarm when any of the steps used in compensation gets lower than the value calculated with the "low limit" setting (alarm limit).

$$\text{Alarm limit} = \frac{\text{initial value} \times \text{Low limit}}{100}$$

(Step low limit values: 20.0↔100.0)

3.2.1.2.8.11 IN Alarm Menu

This sub-menu is used for neutral current alarm settings. Settings are the same for the settings for Alarm->V(L-N) menu. (IN high limit values: 0.000↔30000.000)

3.2.1.2.8.12 F Alarm Menu

This sub-menu is used for frequency alarm settings. Settings are the same for the settings for Alarm->V(L-N) menu. (Frequency low and high limit values: 35.0↔70.0)

3.2.1.2.8.13 V Harmonics Alarm Menu

This sub-menu is used for harmonics alarm settings. User shall select the desired tab with up and down arrows and press "OK".

Settings->Setup->Alarm->Harmonics V		
Alarm relay	Off	Off
THDV hi limit	0.0	
V3 hi limit	0.0	
V5 hi limit	0.0	%
V7 hi limit	0.0	%
V9 hi limit	0.0	%
V11 hi limit	0.0	%
V13 hi limit	0.0	%
V15 hi limit	0.0	%
V17 hi limit	0.0	%
V19 hi limit	0.0	%
V21 hi limit	0.0	%

Fig. 3-58 V Harmonics Alarm Menu

Alarm relay:

Refer to 3.2.1.1.8.1 V(L-N) - Alarm relay.

THDV High Limit:

This is used for entering high limit value of total harmonic distortion in the voltage. In order to set a THDV alarm, user shall enter a number higher than zero as THDV high limit. If zero is entered as the high limit value, THDV parameter is turned off or alarms.

It may be selected between 0.0 and 100.0. (For the usage of RAPIDUS Virtual Keyboard, Refer to 3.1.4 Ex.).

THDV hi limit	20.0	%
---------------	------	---

Fig. 3-59 THDV High Limit Setting

V3 --- V21 high limit:

This is used for entering high limit value of “3rd”, “5th” ... “21st” harmonic distortion in the voltage. In order to set a V3, V5 – V21 harmonic alarm, user shall enter a number higher than zero as high limit. If zero is entered as the high limit value, V3, V5 – V21 parameters are turned off or alarms.

It may be selected between 0.0 and 100.0. (For the usage of RAPIDUS Virtual Keyboard, Refer to 3.1.4 Ex.)

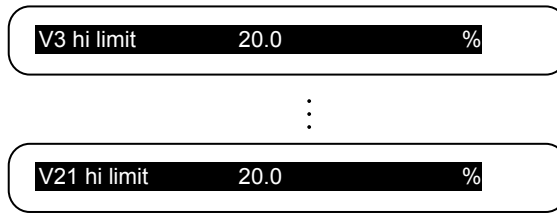

Fig. 3-60 V3-V21 Harmonics High Limit Setting

Delay:

Refer to 3.2.1.1.8.1 V(L-N) – Delay.

3.2.1.2.8.14 I Harmonics Alarm Menu

Settings for the “I harmonics” alarms are the same for the settings for “V harmonics”.

3.2.1.2.8.15 Temperature Alarm Menu

This sub-menu is used for temperature alarm settings. Settings are the same for the settings for Alarm->V(L-N) menu. (Temperature low and high limit values: It may be selected between -20.0 and 55.0).



If low limit and high limit values entered are the same, RAPIDUS does not give an alarm.

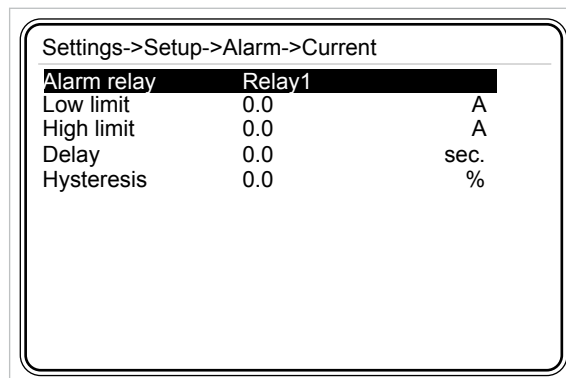

Fig. 3-61 No Alarm Time Condition



If low limit entered is higher than the high limit, "Invalid limits! Please check" message is displayed on RAPIDUS screen.

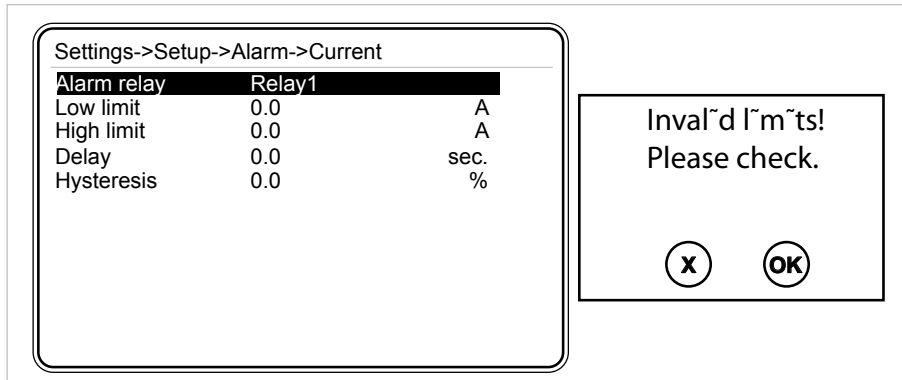

Fig. 3-62 Invalid Limit

3.2.1.2.9 Clear Menu

Sub menus are displayed when you press OK when the Clear option selected. User shall select the tab to be cleared with up and down arrows and press "OK". Relevant clearing operation is performed if you press OK when "Are you sure?" message is displayed on the screen; and it returns back without clearing when you press X.

Energy and demand values are cleared. Learned connections are returned back to factory presets.

All tab performs all of the three operations above.

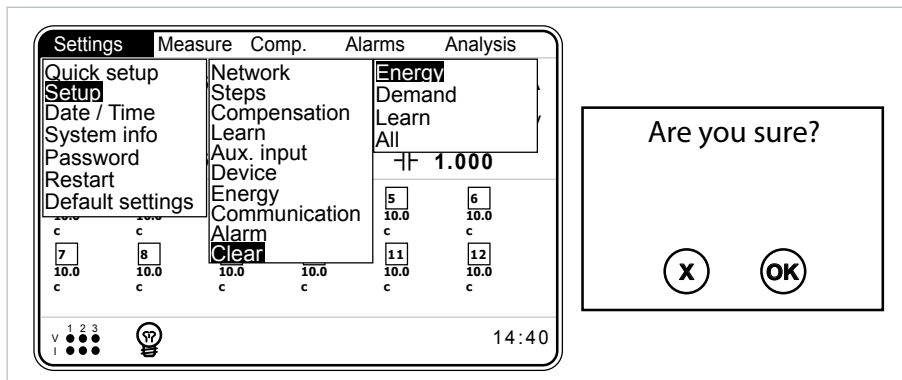

Fig. 3-63 Clear Menu

Assume that for a RAPIDUS used for some time, "Measure->Energy->Imp. Active" sub menu is like the one in Fig. 3-64.

Measure->Energy->Imp. active		
Index	267500.1	kWh
Curr. hour	0.5	kWh
Prev. hour	0.6	kWh
Curr. day	21.3	kWh
Prev. day	22.6	kWh
Curr. month	598.4	kWh
Prev. month	439.5	kWh

Fig. 3-64 Before Clearing

After the clearing operation is completed, "Measure->Energy->Imp. Active" sub menu shall be like the one in Fig. 3-65.

Measure->Energy->Imp. active		
Index	0.0	kWh
Curr. hour	0.0	kWh
Prev. hour	0.0	kWh
Curr. day	0.0	kWh
Prev. day	0.0	kWh
Curr. month	0.0	kWh
Prev. month	0.0	kWh

Fig. 3-65 After Clearing

After the clearing operation, a number different than zero may be seen for index parameters. This number is the initial value entered by the user for the relevant index parameter.

For example, assume that initial value for "Setup->Energy->T1 kWh" is entered as 7500 kWh. Then, after the clearing operation is completed, "Counters->Rate 1->Imp. Active->Index" value shall be 7500 kWh. (See Fig. 3-66)

Measure->Energy->Imp. active		
Index	7500.0	kWh
Curr. hour	0.0	kWh
Prev. hour	0.0	kWh
Curr. day	0.0	kWh
Prev. day	0.0	kWh
Curr. month	0.0	kWh
Prev. month	0.0	kWh

Fig. 3-66 Initial Value Entered After Clearing

3.2.1.3 Date/Time Menu

Date/Time is set in this menu. (For RAPIDUS Date/Time Setting, Refer to 3.1.4 Ex.).

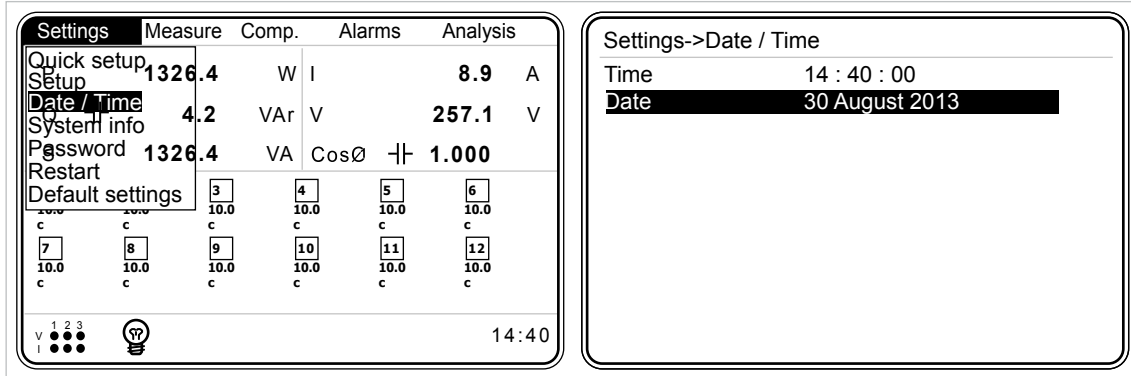

Fig. 3-67 Date/Time Menu

3.2.1.4 System Info Menu

No setting is performed in this menu, it is just for informational purposes.

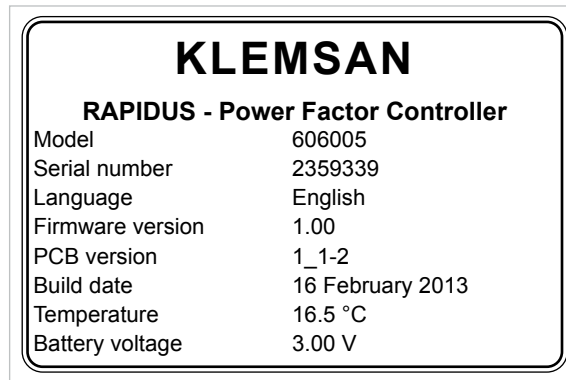

Fig. 3-68 System Info

Temperature and battery voltage values may be read via RS485.

3.2.1.5 Password Menu

If no password is entered, only Date/Time, System Info and Password tabs shall be active under settings menu. You shall enter a password in order to activate the other tabs.

“Login success” shall be displayed if the password entered is correct; and “Password mismatch” message shall be displayed if it is incorrect. (For the usage of RAPIDUS Virtual Keyboard, Refer to 3.1.4 Ex.).

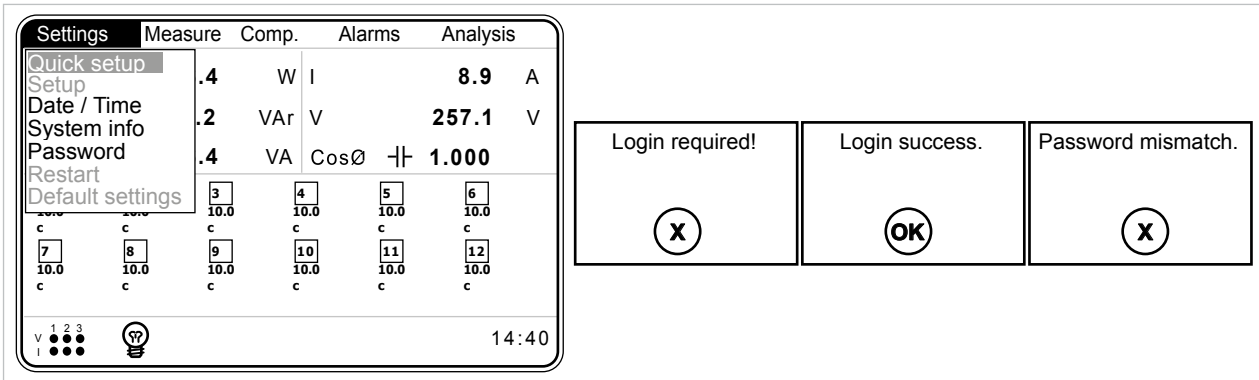

Fig. 3-69 Password

3.2.1.6 Restart Menu

This is used for restarting RAPIDUS. “Are you sure?” message shall be displayed if you press OK when the Restart tab is highlighted. RAPIDUS is restarted by pressing OK again.

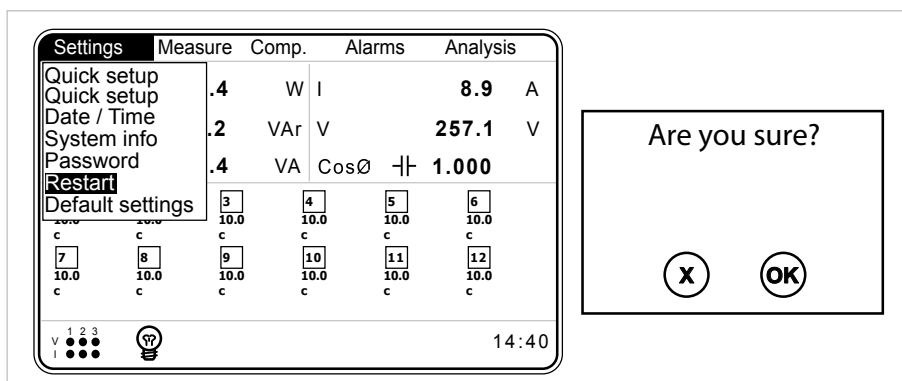

Fig. 3-70 RAPIDUS Restart

3.2.1.7 Default Settings

Default settings menu is used to return back to factory settings. After this operation, all settings other than date and time are returned back to factory settings.

Note: Index values are not reset after this operation.

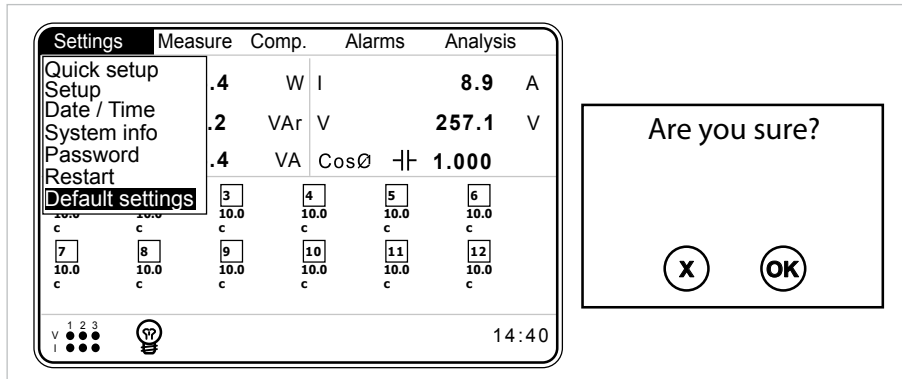

Fig. 3-71 Default Settings

3.2.2 Measure Menu

Sub-menus below are available under the measurements menu. User shall select the desired tab with up and down arrows and press "OK".

- Instantaneous
- Energy
- Demand
- Phasor diagram
- Harmonics

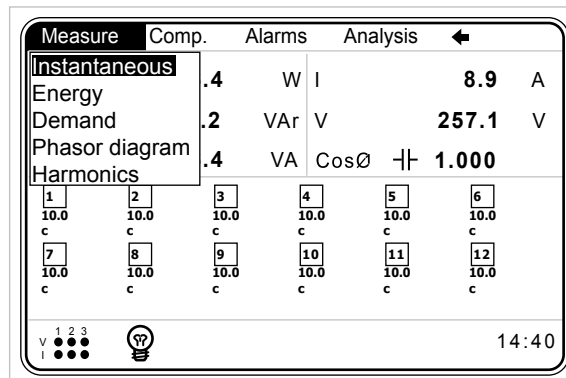

Fig. 3-72 Measure Menu



3.2.2.1 Instantaneous Menu

Instantaneous measurement values are available in this menu. Page in fig. 3-73 shall be displayed when OK is pressed while Measure menu, Instantaneous tab is highlighted. Instantaneous measurement parameters listed below are monitored using the right and left arrow keys.

Measure->Instantaneous->V L-N		
V1	220.0	V
V2	220.0	V
V3	220.0	V
V0	220.0	V
← Powers V L-N V L-L →		

Fig. 3-73 Instantaneous Menu

- Phase voltage (L-N) values and average voltage (L-N) value
- Phase voltage (L-L) values and average voltage (L-L) value
- Phase currents total current (I) value
- Neutral current (IN)
- CosØ values of phases and CosØ value of the system
- Power factor (PF) values of phases and total power factor (PF)
- Active power (P) values of phases and total active power (P) value
- Reactive power (Q) values of phases and total reactive power (Q) value
- Apparent power (S) values of phases and total apparent power (S) value
- Frequency (F) values of phases
- THDV values of phases and total THDV value
- THDI values of phases and total THDI value

3.2.2.2 Energy Menu

This menu includes

- Imported active
- Exported active
- Inductive reactive
- Capacitive reactive

energy values.



When an energy meter reaches the value "50000000.0 Mega", it will start to count from "0.0".

3.2.2.2.1 Imp. Active Menu (Imported Active Energy Menu)

Imported active energy values are displayed.

Measure->Energy->Imp. active		
Index	0.0	kWh
Curr. hour	0.0	kWh
Prev. hour	0.0	kWh
Curr. day	0.0	kWh
Prev. day	0.0	kWh
Curr. month	0.0	kWh
Prev. month	0.0	kWh

Fig. 3-74 Imp. Active Energy Page

Index

is the imported active energy value from the time when the energy values are cleared to this moment.

Curr. hour

is the imported active energy value from the start of the hour to this moment.

Prev. hour

is the active energy value imported during the previous hour.

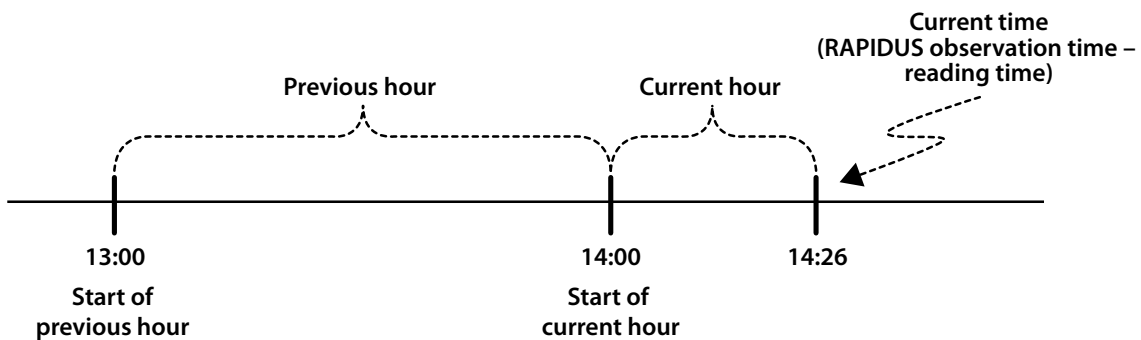

Fig. 3-75 Hour Start Example

Curr. day

is the imported active energy value from the starting hour of the day to this moment.

Prev. day

is the active energy value imported during the previous day.

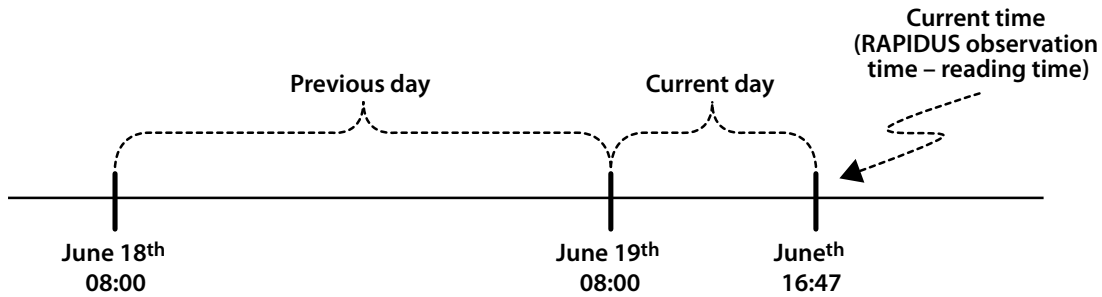

*Starting hour of the day: 8

Fig. 3-76 Day Start Example

Curr. month

is the imported active energy value from the starting day of the month to this moment.

Prev. month

is the active energy value imported during the previous month.

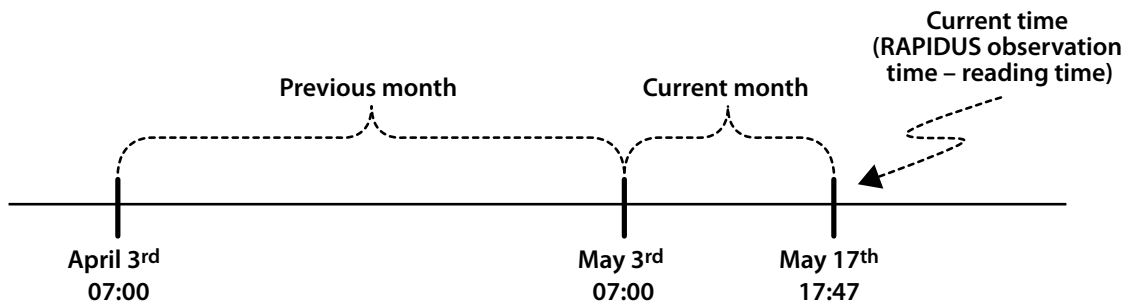

*Starting hour of the day: 7
*Starting day of the month: 3

Fig. 3-77 Month Start Example

Settings for "start of day" and "start of month" parameters which are important for the usage of energy menu page are performed on "Settings->Setup->Energy" menu.

Example:

Assume that start of the day time is assigned as "0". Then, when the system clock shows 00:00, the value in the "Curr. day" tab shall be recorded in the "prev. day" tab. "Curr. day" shall be reset and starts to count from zero.

Example:

Assume that start of the month day is assigned as "1" and start of the day time is assigned as "0".

Then, when day of the moth is 1, and hour is 00:00, the value in the "Curr. month" tab shall be recorded in the "prev. month" tab. "Curr. month" shall be reset and starts to count from zero.

3.2.2.2 Exp. Active Menu (Exported Active Energy Menu)

The explanations for "Exp. active" menu are the same as 3.2.2.2.1 (Measure->Energy->Imp. Active) energy menu.

3.2.2.2.3 Ind. Reactive Menu (Inductive Reactive Energy Menu)

The explanations for "Ind. reactive" menu are the same as 3.2.2.2.1 (Measure->Energy->Imp. Active) energy menu.

3.2.2.2.4 Cap. Reactive Menu (Capacitive Reactive Energy Menu)

The explanations for "Cap. reactive" menu are the same as 3.2.2.2.1 (Measure->Energy->Imp. Active) energy menu.

3.2.2.3 Demand Menu

Highest values of the averages occurred in the currents and powers during the set demand period are displayed on the demand menu. Demand values are recorded with time information. On the demand sub menus, current and power values and sum of these values are shown for each phase.

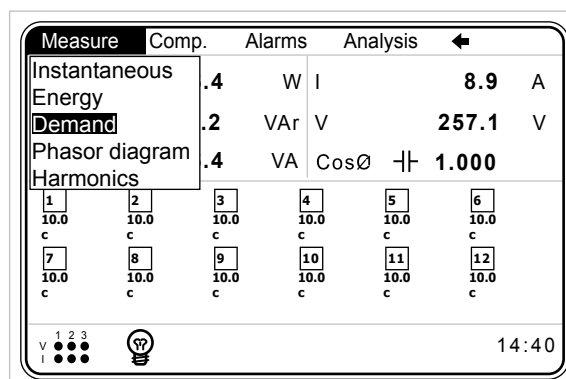
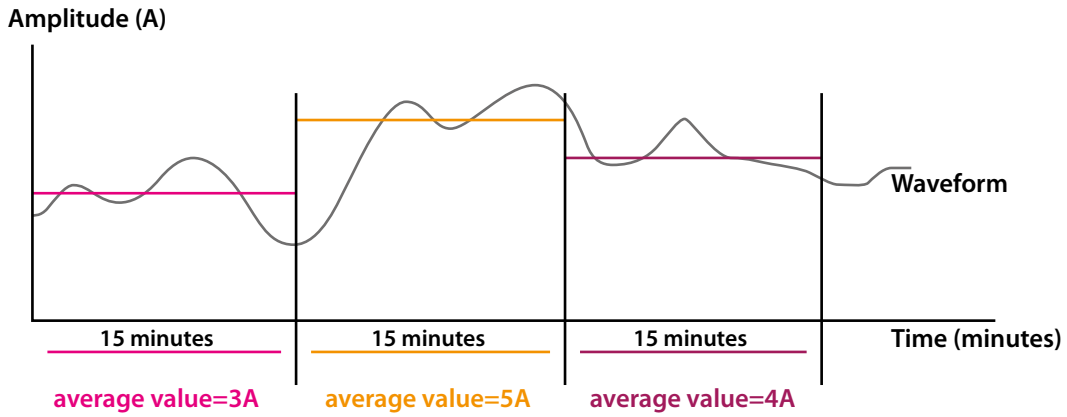

Fig. 3-78 Demand Menu

Example:

Current signal averages and demand value for 15 minutes demand period are shown in the following graphic.



average value=3A average value=5A average value=4A

demand period=15 minutes

Fig. 3-79 Demand Example

3.2.2.3.1 Current Menu

Demand values for each phase current and the demand value for the sum of the phase currents are shown. Bottom tab of the demand values indicate the date and time they have occurred.

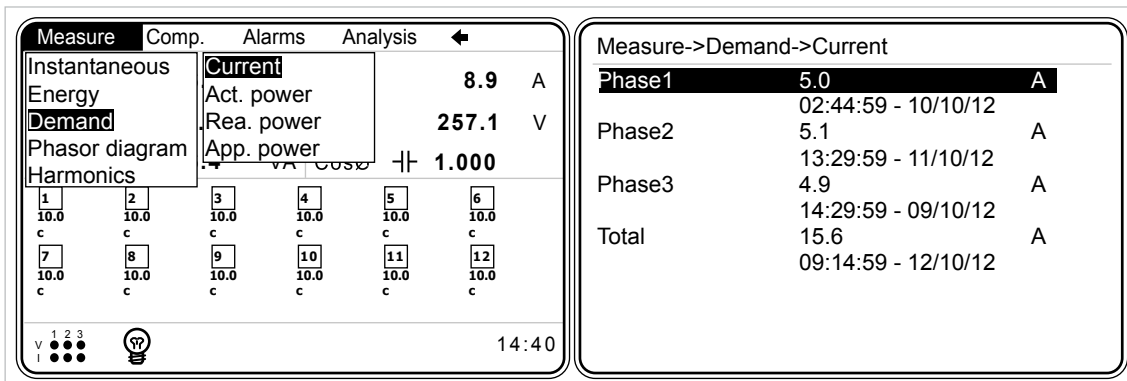

Fig. 3-80 Current Menu

Example:

Assume that the demand period is entered as 15 minutes and current value demand value and time are read as Phase1 5.0 A 02:44:59 - 10/10/13. Then, the description for the value read is as follows:

On October 10th, 2013, at 02:29:59 and 02:44:59 period, demand value for 1st phase is 5.0 A.

Example:

Demand periods when the demand period is set as 15 minutes when system clock is 15:07:00 are shown below:

05:07:00 - 15:14:59 = 1st demand period
15:14:59 - 15:29:59 = 2nd demand period
15:29:59 - 15:44:59 = 3rd demand period
15:44:59 - 15:59:59 = 4th demand period
15:59:59 - 16:14:59 = 5th demand period
.
.
.

3.2.2.3.1.1 Act. Power Menu

Demand values in the active power sub menu are as described in "Measure->Demand->Current" sub menu.

3.2.2.3.1.2 Rea. Power Menu

Demand values in the reactive power sub menu are as described in "Measure->Demand->Current" sub menu.

3.2.2.3.1.3 App. Power Menu

Demand values in the apparent power sub menu are as described in "Measure->Demand->Current" sub menu.

3.2.2.4 Phasor diagram Menu

Following information are listed on the right side of the diagram on phasor diagram menu screen.

- voltage values for phases
- current values for phases
- Angle values between V1-V2, V2-V3 and V3-V1
- Angle values between V1-I1, V2-I2 and V3-I3

On the phasor diagram, current lines are displayed as gray and voltage lines are displayed as black.

In order to follow the currents and voltages pertaining to the same phase more easily in phasor diagram, circles with the same size are added to the ends of the lines pertaining to the same phase.

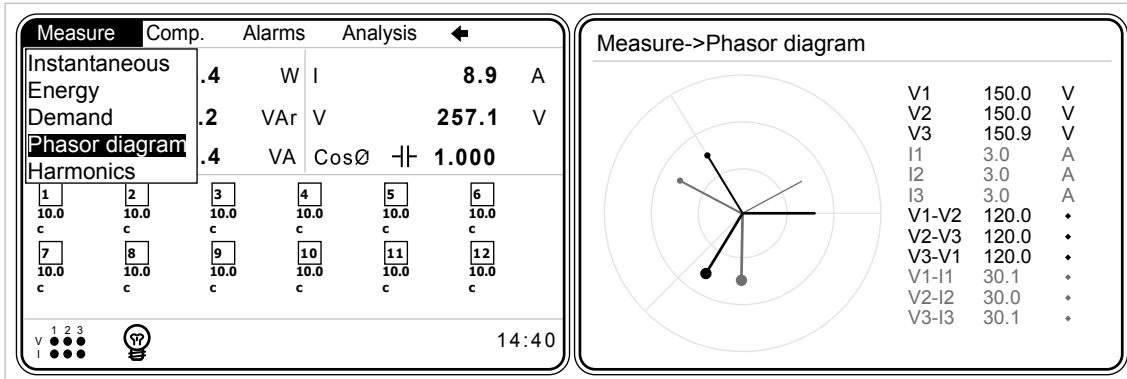

Fig. 3-81 Phasor Diagram Menu

3.2.2.5 Harmonics Menu

RAPIDUS measures/calculates current and voltage harmonics up to 51st level. Current and voltage harmonics are displayed both in tabular and graphic form.

3.2.2.5.1 Table Menu

Current and voltage harmonics pertaining to each phase are displayed in tabular form in this menu (See Fig. 3-82). User may navigate between tables by pressing right and left arrows.

There are 6 table pages. V1, V2, V3, I1, I2, I3.

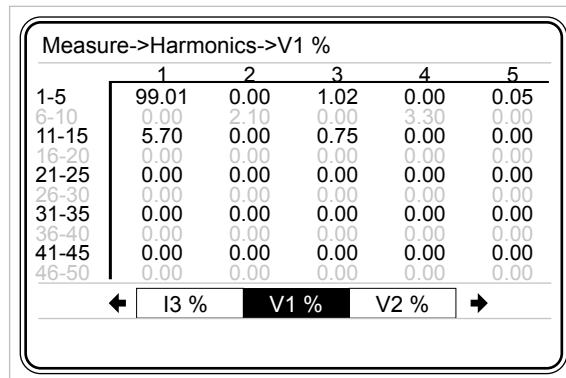

Fig. 3-82 Harmonics Table Menu

3.2.2.5.2 Graphic Menu

Current and voltage harmonics pertaining to each phase are displayed in graphic form in this menu (See Fig. 3-83). User may navigate between current-voltage graphics by pressing right and left arrows. There are 6 graphic pages: V1, V2, V3, I1, I2, I3.

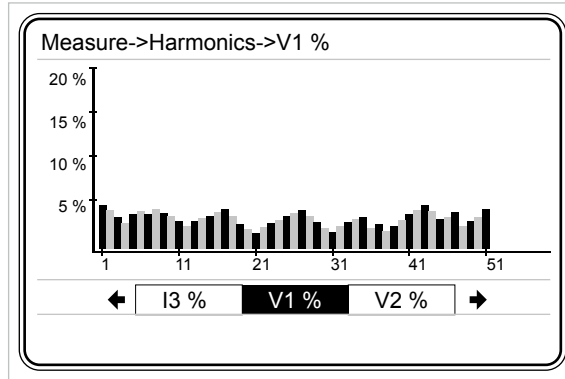

Fig. 3-83 Graphic Menu

3.2.3 Comp. (Compensation) Menu

Sub menus shown in Fig. 3-84 are available.

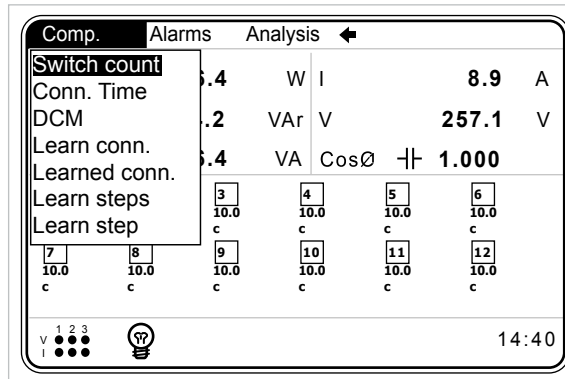

Fig. 3-84 Comp. Menu

3.2.3.1 Switch Count Menu

This menu displays how many times RAPIDUS activated each step.

In order to clear/change switching counts, highlight the desired step and press OK. Switch count is set between 0 and 10000. (For the usage of RAPIDUS Virtual Keyboard, Refer to 3.1.4 Ex.).

Comp.->Switch count	
Step 1	0
Step 2	0
Step 3	0
Step 4	0
Step 5	0
Step 6	0
Step 7	0
Step 8	0
Step 9	0
Step 10	0
Step 11	0
Step 12	0

NOTE: There are two "Switch Count" submenus for RAPIDUS 232R-E. Operator can assign 1st, 2nd, ... and 12th step powers in "Switch Count 1" Submenu. Operator can assign 13th, 14th, ...and 24th step powers in "Switch Count 2" Submenu.

Fig. 3-85 Switch Count

3.2.3.2 Conn. Time Menu

Connection times of the steps are displayed.

In order to clear/change connection times, highlight the desired step and press OK. Conn. time is set between 0 and 1000000. (For the usage of RAPIDUS Virtual Keyboard, Refer to 3.1.4 Ex.).

Comp.->Conn. time		
Step 1	0	min
Step 2	0	min
Step 3	0	min
Step 4	0	min
Step 5	0	min
Step 6	0	min
Step 7	0	min
Step 8	0	min
Step 9	0	min
Step 10	0	min
Step 11	0	min
Step 12	0	min

NOTE: There are two "Conn. Time" submenus for RAPIDUS 232R-E. Operator can assign 1st, 2nd, ... and 12th step powers in "Conn. Time 1" Submenu. Operator can assign 13th, 14th, ...and 24th step powers in "Conn. Time 2" Submenu.

Fig. 3-86 Conn. Time

3.2.3.3 DCM (Dynamic Capacitor Monitoring)

Step values learned by dynamic monitoring can be followed from this menu. These are observed after a certain amount of time due to the effects and nature of DCM algorithm.

There is no compensation program with a prerequisite for DCM. DCM shall estimate step powers in each compensation program.

First estimation results require at least 128x8 compensation switching. Estimation values shall be updated at every 128 compensation switching after that. Previous estimation power is the entered or learned step power values.

If one of estimated step value(that is defined by DCM algorithm) is lower than 20% of previous value or higher than 180% of previous value, related step won't be used in compensation.

In this situation, related step and its connection must be checked.

NOTE: DCM(Dynamic Capacitor Monitoring) feature isn't available in RAPIDUS 232R-E optional model.

3.2.3.4 Learn Conn. Menu

Connections of current and voltage measurement inputs are learned.

RAPIDUS learns the connections by activating a 3-phase capacitor. Relevant capacitor is determined with the "Step number" tab on the 'Quick Setup' or 'Settings->Setup->Learn->Learn Conn.' menu.

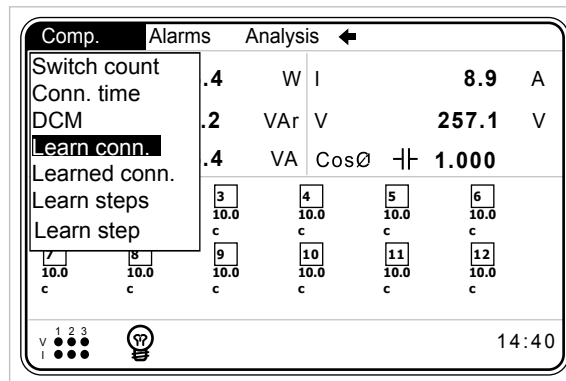

Fig. 3-87 Learn Conn.



If "3.2.1.2.4.1.1 Learn at start of" is set as "On", connections are learned again and again when Rapidus is restarted or powered on. After connections are learned by Rapidus, it is recommended to use that setting as "Off". Otherwise connection can be learned wrongly.



On the "Step number" setting, the step number that the capacitor with the highest power value is connected shall be entered.

3.2.3.5 Learned Conn. Menu

Connections learned by RAPIDUS are displayed.

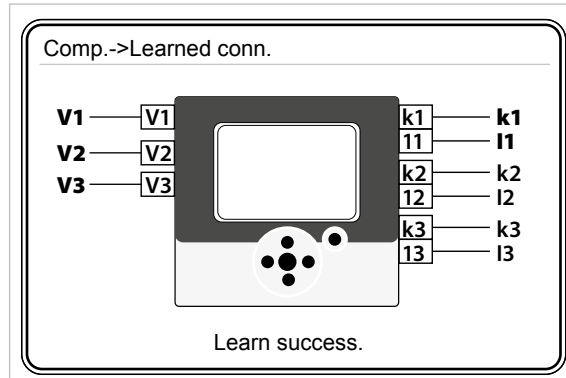

Fig. 3-88 Learned Conn. Example-1

Explanation of Fig. 3-88

Voltage lines of network;

Phase 1; is connected to V1 terminal of Rapidus.

Phase 2; is connected to V2 terminal of Rapidus.

Phase 3; is connected to V3 terminal of Rapidus.

Current lines of network;

Phase 1; is connected to I1 terminal of Rapidus correctly(I1,k1).

Phase 2; is connected to I2 terminal of Rapidus correctly(I2,k2).

Phase 3; is connected to I3 terminal of Rapidus correctly(I3,k3).

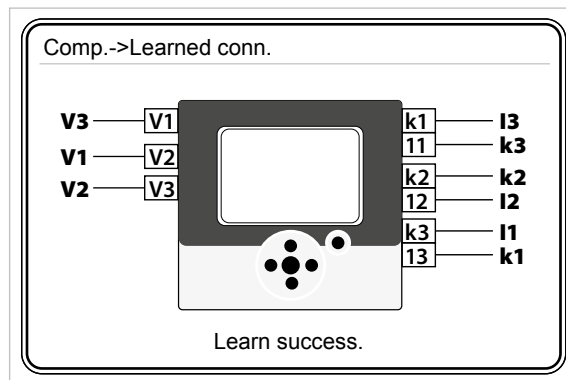

Fig. 3-89 Learned Conn. Example-1

Explanation of Fig. 3-89

Voltage lines of network;

Phase 1; is connected to V2 terminal of Rapidus.

Phase 2; is connected to V3 terminal of Rapidus.

Phase 3; is connected to V1 terminal of Rapidus.

Current lines of network;

Phase 1; is connected to I3 terminal of Rapidus reversly(I1,k1).

Phase 2; is connected to I2 terminal of Rapidus correctly(k2,I2).

Phase-3; is connected to I1 terminal of Rapidus reversly(I3,k3).

3.2.3.6 Learn Steps Menu

RAPIDUS learns the power and type of capacitors or shunt reactors connected to its steps by activating them in order.

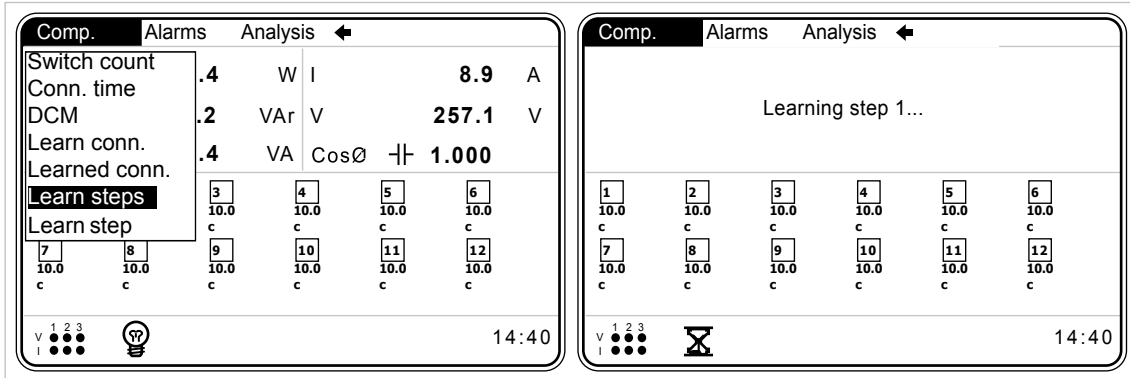

Fig. 3-90 Learn Steps



No load (current amplitude and $\cos\phi$) changes shall occur in the system to ensure that step powers are learned correctly. Otherwise, RAPIDUS may learn step powers and step types incorrectly.

3.2.3.7 Learn Step Menu

RAPIDUS learns specified step power and its type by this menu.

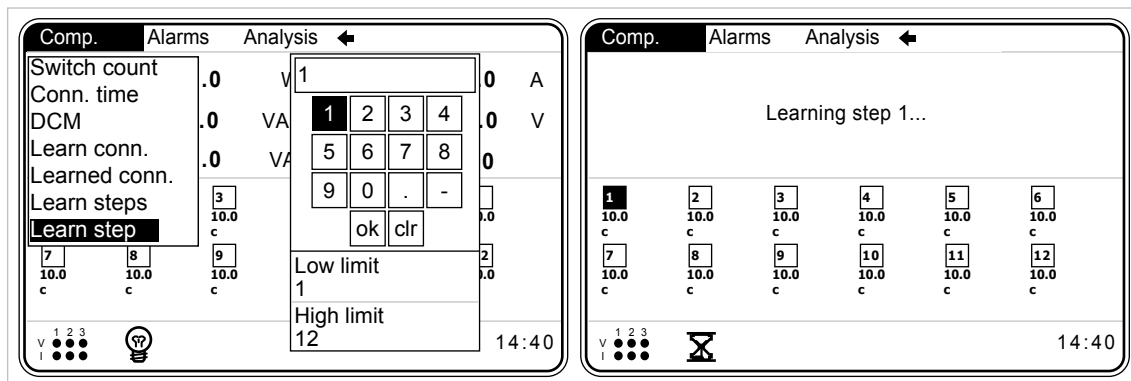

Fig. 3-91 Learn Step

3.2.4 Alarms Menu

RAPIDUS alarms may be monitored from alarms menu. Sub menus are Phase1, Phase2, Phase3, Step and Other.

A total of 50 alarm conditions with their times are recorded on the RAPIDUS MODBUS table. When the number of alarm conditions exceed 50, last occurring alarm conditions is written over the 1st alarm.

On the MODBUS table, the descriptions for the variables related with the alarm conditions are as follows:

Alarm Timestamp : Carries alarm time information. It has 32 bit int. data structure.

Alarm Description : This is the bit number on the alarm tags. Thus, user may match the relevant bit on the alarm tag and the alarm. Refer to the example.

Alarm Status : Indicates alarm entry or alarm exit status. Both alarm entry and alarm exit are events for RAPIDUS. Both are recorded in MODBUS table.

1 -> Alarm entry
0 -> Alarm exit

Alarm Value : Current value of the parameter related with the alarm
For more details, refer to Modbus document.

Example:

Assume 100 VAC is entered as the low limit value for phase1, phase2 and phase3 voltages and phase3 voltage has gone under 100VAC in the system. In this case,

Alarm Description is the index number of the relevant alarm bit in the alarm tags. Thus, for the condition above, "alarm description value" shall be 3.

Briefly, you can use the number under this heading as an index in the alarm tags to reach the description of alarm. Moreover, user matches the alarm and alarm tag.

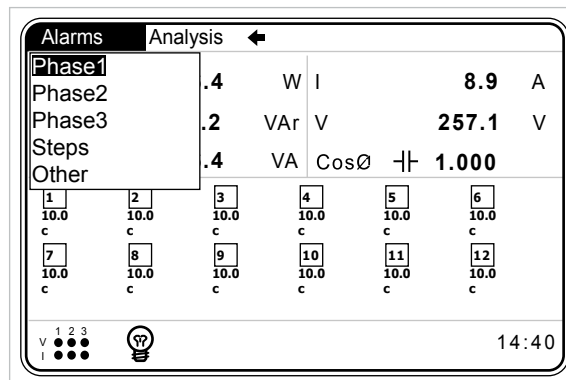

Fig. 3-92 Alarms Menu

3.2.4.1 Phase1 Menu

Statuses of alarms pertaining to 1st phase are shown in Phase1 menu.

"Normal" → NO Alarm

"Alarm" → Alarm AVAILABLE

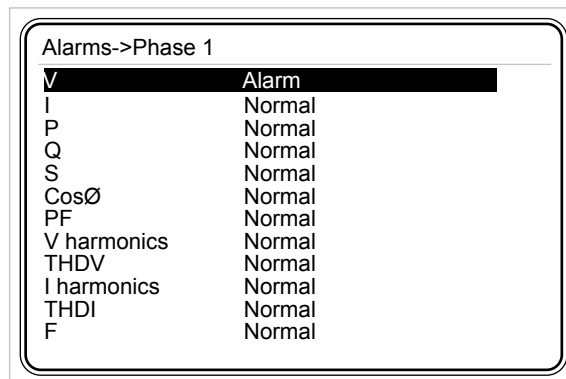

Fig. 3-93 Phase1 Menu

Following alarm statuses are monitored in Phase1 menu.

- V (phase-neutral voltage)
- I (current)
- P (active power)
- Q (reactive power)
- S (apparent power)
- CosØ
- PF (power factor)
- V harmonics (up to 21st voltage harmonics)
- THDV voltage (total harmonics distortion in the voltage)
- I harmonics (up to 21st current harmonics)
- THDI (total harmonics distortion in the current)
- F (frequency)

3.2.4.2 Phase2 Menu

Phase2 menu descriptions are the same as the Phase1 menu descriptions.

3.2.4.3 Phase3 Menu

Phase3 menu descriptions are the same as the Phase1 menu descriptions.

3.2.4.4 Step Menu

Descriptions of Normal and Alarm warnings are the same as Phase1 menu in “Step” menu.

RAPIDUS gives an alarm when any of the steps used in compensation gets lower than the value calculated with the “low limit” setting (alarm limit).

Alarms->Steps	
Step 1	Normal
Step 2	Normal
Step 3	Normal
Step 4	Normal
Step 5	Normal
Step 6	Normal
Step 7	Normal
Step 8	Normal
Step 9	Normal
Step 10	Normal
Step 11	Normal
Step 12	Normal

Fig. 3-94 Step Menu

3.2.4.5 Other Menu

Descriptions of Normal and Alarm warnings are the same as Phase1 menu in “Other” menu.

Alarms->Other	
Under comp.	Normal
Over comp.	Normal
Ind. energy	Alarm
Cap. energy	Alarm
VLL12	Normal
VLL23	Normal
VLL31	Normal
IN	Normal
Temperature	Normal
Battery	Normal

Fig. 3-95 Other Menu

Following alarm statuses are observed in “Other” menu.

- Under comp.
- Over comp.
- Ind. energy
- Cap. energy
- VLL12 (phase1-phase2 voltage)
- VLL23 (phase2-phase3 voltage)
- VLL31 (phase3-phase1 voltage)
- IN (Neutral current)
- Temperature
- Battery

When the battery voltage is less than 1.9V, RAPIDUS gives a battery alarm. When RAPIDUS gives a battery alarm, please contact the authorized dealer you have purchased the device (or nearest authorized dealer).

3.2.5 Analysis Menu

This menu contains sub menus shown in Fig. 3-96. Analysis menu parameters can be read from MODBUS table.

Analysis					
Minimum	.4	W	I	8.9	A
Maximum					
Average	.2	VA _r	V	257.1	V
Energy	.4	VA	Cos ϕ	1.000	
1	2	3	4	5	6
10.0	10.0	10.0	10.0	10.0	10.0
c	c	c	c	c	c
7	8	9	10	11	12
10.0	10.0	10.0	10.0	10.0	10.0
c	c	c	c	c	c
					14:40

Fig. 3-96 Analysis Menu



Analysis menu parameters are not stored in nonvolatile memory. Therefore, all parameters pertaining to analysis menu are reset when the device is reset.

3.2.5.1 Minimum Menu

This menu includes hourly, daily and monthly minimum values.

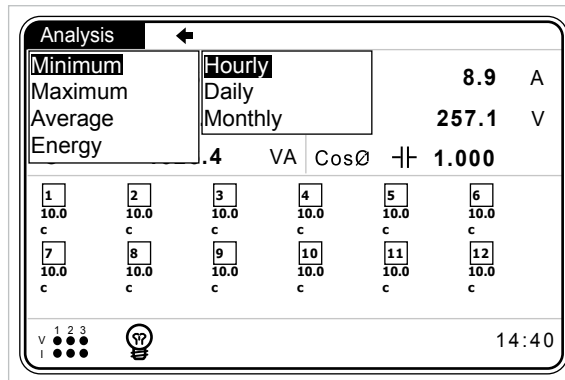

Fig. 3-97 Minimum Menu

3.2.5.1.1 Hourly Menu

This menu includes minimum 'instantaneous' values measured from the start of the hour to current time.

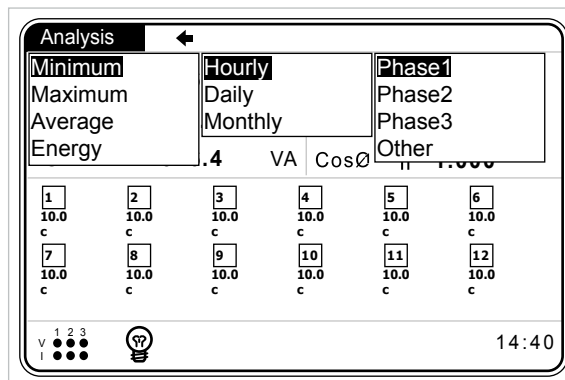

Fig. 3-98 Hourly Menu

3.2.5.1.1.1 Phase1 Menu

Voltage (V), current (I), active power (P), reactive power (Q), apparent power (S), $\cos\phi$, power factor (PF) and frequency (F) values are displayed.

3.2.5.1.1.2 Phase2 Menu

Voltage (V), current (I), active power (P), reactive power (Q), apparent power (S), $\cos\phi$, power factor (PF) and frequency (F) values are displayed.



3.2.5.1.1.3 Phase3 Menu

Voltage (V), current (I), active power (P), reactive power (Q), apparent power (S), $\cos\phi$, power factor (PF) and frequency (F) values are displayed.

3.2.5.1.1.4 Other

VLL12 (phase1-phase2 voltage), VLL23 (phase2-phase3 voltage), VLL31 (phase3-phase1 voltage)

3.2.5.1.2 Daily Menu

This menu includes minimum “instantaneous” values measured from the starting hour of the day (Refer to 3.2.1.2.6.1) to current time. Descriptions of sub menus are the same as the hourly menu.

3.2.5.1.3 Monthly Menu

This menu includes minimum “instantaneous” values measured from the starting day of the month (Refer to 3.2.1.2.6.2) and starting hour of the day (Refer to 3.2.1.2.6.1) to current time. Descriptions of sub menus are the same as the hourly menu.

3.2.5.2 Maximum Menu

Sub menus and descriptions of the sub menus of the “Maximum” menu are the same as “Minimum” menu. Values measured in “Maximum” menu are also “instantaneous” maximum values.

3.2.5.3 Average Menu

Sub menus and descriptions of the sub menus of the “Average” menu are the same as “Maximum” menu. “Average” menu displays the “average” values taken in hourly, daily and monthly periods.

3.2.5.4 Energy Menu

This menu includes hourly, daily and monthly counter values.

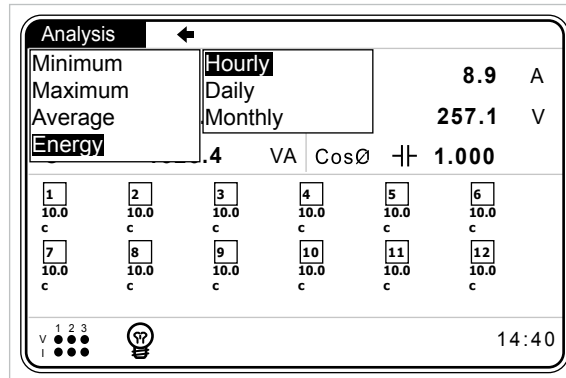

Fig. 3-99 Energy Menu

3.2.5.4.1 Hourly Menu

This menu includes counter values measured from the start of the hour to current time. kWh (imp. active), kWh E. (exp. active), kVArh I (inductive reactive), kVArh C. (capacitive reactive) counter values are displayed.

3.2.5.4.2 Daily Menu

This menu includes counter values measured from the starting hour of the day ([Refer to 3.2.1.2.6.1](#)) to current time.

kWh (imp. active), kWh E. (exp. active), kVArh I (inductive reactive), kVArh C. (capacitive reactive) counter values are displayed.

3.2.5.4.3 Monthly Menu

This menu includes counter values measured from the starting day of the month ([Refer to 3.2.1.2.6.2](#)) and starting hour of the day ([Refer to 3.2.1.2.6.1](#)) to current time.

kWh (imp. active), kWh E. (exp. active), kVArh I (inductive reactive), kVArh C. (capacitive reactive) counter values are displayed.



RAPIDUS

Power Factor
Controller

**SECTION 4
MODBUS
PROTOCOL**

SECTION 4 MODBUS PROTOCOL

4.1 RS485 Wiring Diagram

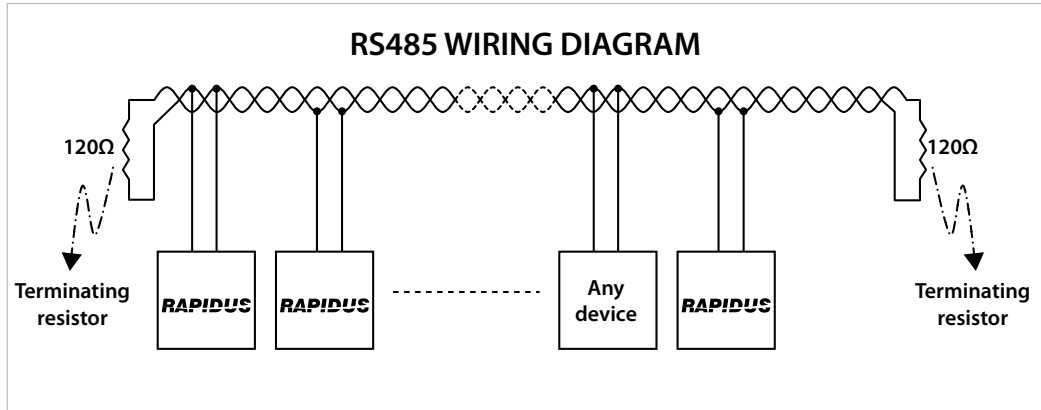

Figure 4-1 RS485 Wiring Diagram

4.2 Computer Connection

RAPIDUS can communicate with PCs via USB-RS85 or RS232-RS485 converters.

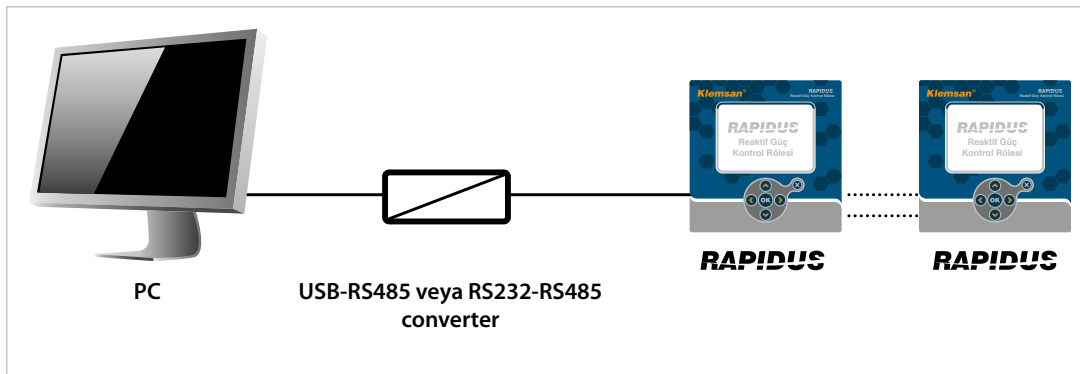

Figure 4-2 RS485 PC Connection



4.3 Message Format and Data Types of MODBUS-RTU Protocol

RAPIDUS, implements modbus RTU protocol. Modbus RTU message format is as follows.

Table 4-1 Message Format

Start	Address	Function	Data	CRC	End
≥ 3.5 byte	1 byte	1 byte	0-252 byte	2 byte	≥ 3.5 byte

There should be a time gap, which is at least 3.5 characters wide, between RTU messages.

For instance, when client device requests any information, server device should reply after at least a 3.5 character wide time gap. Following the response of the server, client device should wait 3.5 characters long period, before requesting information again.

Data types used in RAPIDUS are as follows.

Table 4-2 int (32 bit) data type

b31 (Bit 31)	-----	b0 (Bit 0)
MSB (Most Significant Bit)	-----	LSB (Least Significant Bit)

int:

32-bit integer value. Byte order starts from the lowest byte address as b0, b1, b2 and so on.

float:

It is a 32-bit floating-point number in IEEE 754 standard.

string:

Character array in ASCII standard. It is only used for RAPIDUS device name and RAPIDUS configuration name variables.

4.4 Implemented functions for MODBUS-RTU Protocol

Table 4-3 Implemented functions for MODBUS RTU Protocol

Function Name	Function Code
Read Holding Registers	03H (decimal value 3)
Write Single Register	06H (decimal value 6)
Write Multiple Registers	10H (decimal value 16)
Read file record	14H (decimal value 20)



4.5 Data and Setting Parameters for RAPIDUS

4.5.1 Measured and Calculated Data



Calculated and measured data are “read-only” values.

Operator/programmer can reach all measured and calculated data via MODBUS RTU protocol. Starting address for measured and calculated data is 0.

Example:

Three phase average voltage is read via the 0th and 1th registers (16 bits + 16 bits = 32 bit).

PC (or PLC) Request		RAPIDUS Response	
Slave ID	01h	Slave ID	01h
Function code	03h	Function code	03h
Register address – high	00h	Byte counts	04h
Register address – low	00h	Register value - high (0)	43h
Number of registers– high	00h	Register value - low (0)	5DH
Number of registers – low	02h	Register value - high (1)	36H
CRC high	C4h	Register value - low (1)	E0h
CRC low	0Bh	CRC high	68h
		CRC low	4Dh

The “Byte counts” information of RAPIDUS response is two times “Number of registers” value of “PC request” (1 register = 2 bytes).

Register value high(0) and low(0) together with register value high(1) and low(1) constitute a 32-bit value. This value should be converted (typecasted) to a float value. The float value of the mentioned 32-bit variable is 221.2143555.



4.5.1.1 Readable Data for RAPIDUS 231R-E

Table 4-4 Readable Data(RAPIDUS 231R-E)

Address	Parameter	Description	R/W	Unit	Data Type
0	V avg.	Average voltage of three phases	RO	V	32 bit flo t
2	I tot.	Total current of three phases	RO	A	32 bit flo t
4	P tot.	Total active power of three phases	RO	W	32 bit flo t
6	Q tot.	Total reactive power of three phases	RO	VAr	32 bit flo t
8	S tot.	Total apparent power of three phases	RO	VA	32 bit flo t
10	CosØ avg.	Average CosØ of three phases	RO	-	32 bit flo t
12	PF avg.	Average PF of three phases	RO	-	32 bit flo t
14	VLL12	Voltage V1-2	RO	V	32 bit flo t
16	VLL23	Voltage V2-3	RO	V	32 bit flo t
18	VLL31	Voltage V3-1	RO	V	32 bit flo t
20	VLL avg.	Average of line to line voltage of three phases	RO	V	32 bit flo t
22	IN	Neutral current	RO	A	32 bit flo t
24	THDV tot.	Total har. distortion of voltage for three phases	RO	%	32 bit flo t
26	THDI tot.	Total har. distortion of voltage for three phases	RO	%	32 bit flo t
PHASE 1					
28	L1 V	Phase1 voltage	RO	V	32 bit flo t
30	L1 I	Phase1 current	RO	A	32 bit flo t
32	L1 P	Phase1 active power	RO	W	32 bit flo t
34	L1 Q	Phase1 reactive power	RO	VAr	32 bit flo t
36	L1 S	Phase1 apparent power	RO	VA	32 bit flo t
38	L1 CosØ	Phase1 CosØ	RO	-	32 bit flo t
40	L1 PF	Phase1 power factor	RO	-	32 bit flo t
42	L1 F	Phase1 frequency	RO	Hz	32 bit flo t
44	L1 THDV	Phase1 total har. distortion of voltage	RO	%	32 bit flo t
46	L1 THDI	Phase1 total har. distortion of current	RO	%	32 bit flo t
48	L1 V Harmonics 1	Phase1 voltage first harmonic	RO	%	32 bit flo t
50	L1 V Harmonics 3	Phase1 voltage third harmonic	RO	%	32 bit flo t
52	L1 V Harmonics 5	Phase1 voltage 5th harmonic	RO	%	32 bit flo t
54	L1 V Harmonics 7	Phase1 voltage 7th harmonic	RO	%	32 bit flo t
56	L1 V Harmonics 9	Phase1 voltage 9th harmonic	RO	%	32 bit flo t
58	L1 V Harmonics 11	Phase1 voltage 11th harmonic	RO	%	32 bit flo t
60	L1 V Harmonics 13	Phase1 voltage 13th harmonic	RO	%	32 bit flo t
62	L1 V Harmonics 15	Phase1 voltage 15th harmonic	RO	%	32 bit flo t
64	L1 V Harmonics 17	Phase1 voltage 17th harmonic	RO	%	32 bit flo t
66	L1 V Harmonics 19	Phase1 voltage 19th harmonic	RO	%	32 bit flo t
68	L1 V Harmonics 21	Phase1 voltage 21st harmonic	RO	%	32 bit flo t
70	L1 V Harmonics 23	Phase1 voltage 23rd harmonic	RO	%	32 bit flo t
72	L1 V Harmonics 25	Phase1 voltage 25th harmonic	RO	%	32 bit flo t
74	L1 V Harmonics 27	Phase1 voltage 27th harmonic	RO	%	32 bit flo t
76	L1 V Harmonics 29	Phase1 voltage 29th harmonic	RO	%	32 bit flo t
78	L1 V Harmonics 31	Phase1 voltage 31st harmonic	RO	%	32 bit flo t

Address	Parameter	Description	R/W	Unit	Data Type
80	L1 V Harmonics 33	Phase1 voltage 33rd harmonic	RO	%	32 bit flo t
82	L1 V Harmonics 35	Phase1 voltage 35th harmonic	RO	%	32 bit flo t
84	L1 V Harmonics 37	Phase1 voltage 37th harmonic	RO	%	32 bit flo t
86	L1 V Harmonics 39	Phase1 voltage 39th harmonic	RO	%	32 bit flo t
88	L1 V Harmonics 41	Phase1 voltage 41st harmonic	RO	%	32 bit flo t
90	L1 V Harmonics 43	Phase1 voltage 43rd harmonic	RO	%	32 bit flo t
92	L1 V Harmonics 45	Phase1 voltage 45th harmonic	RO	%	32 bit flo t
94	L1 V Harmonics 47	Phase1 voltage 47th harmonic	RO	%	32 bit flo t
96	L1 V Harmonics 49	Phase1 voltage 49th harmonic	RO	%	32 bit flo t
98	L1 V Harmonics 51	Phase1 voltage 51st harmonic	RO	%	32 bit flo t
100	L1 I Harmonics 1	Phase1 current first harmonic	RO	%	32 bit flo t
102	L1 I Harmonics 3	Phase1 current third harmonic	RO	%	32 bit flo t
104	L1 I Harmonics 5	Phase1 current 5th harmonic	RO	%	32 bit flo t
106	L1 I Harmonics 7	Phase1 current 7th harmonic	RO	%	32 bit flo t
108	L1 I Harmonics 9	Phase1 current 9th harmonic	RO	%	32 bit flo t
110	L1 I Harmonics 11	Phase1 current 11th harmonic	RO	%	32 bit flo t
112	L1 I Harmonics 13	Phase1 current 13th harmonic	RO	%	32 bit flo t
114	L1 I Harmonics 15	Phase1 current 15th harmonic	RO	%	32 bit flo t
116	L1 I Harmonics 17	Phase1 current 17th harmonic	RO	%	32 bit flo t
118	L1 I Harmonics 19	Phase1 current 19th harmonic	RO	%	32 bit flo t
120	L1 I Harmonics 21	Phase1 current 21st harmonic	RO	%	32 bit flo t
122	L1 I Harmonics 23	Phase1 current 23rd harmonic	RO	%	32 bit flo t
124	L1 I Harmonics 25	Phase1 current 25th harmonic	RO	%	32 bit flo t
126	L1 I Harmonics 27	Phase1 current 27th harmonic	RO	%	32 bit flo t
128	L1 I Harmonics 29	Phase1 current 29th harmonic	RO	%	32 bit flo t
130	L1 I Harmonics 31	Phase1 current 31st harmonic	RO	%	32 bit flo t
132	L1 I Harmonics 33	Phase1 current 33rd harmonic	RO	%	32 bit flo t
134	L1 I Harmonics 35	Phase1 current 35th harmonic	RO	%	32 bit flo t
136	L1 I Harmonics 37	Phase1 current 37th harmonic	RO	%	32 bit flo t
138	L1 I Harmonics 39	Phase1 current 39th harmonic	RO	%	32 bit flo t
140	L1 I Harmonics 41	Phase1 current 41st harmonic	RO	%	32 bit flo t
142	L1 I Harmonics 43	Phase1 current 43rd harmonic	RO	%	32 bit flo t
144	L1 I Harmonics 45	Phase1 current 45th harmonic	RO	%	32 bit flo t
146	L1 I Harmonics 47	Phase1 current 47th harmonic	RO	%	32 bit flo t
148	L1 I Harmonics 49	Phase1 current 49th harmonic	RO	%	32 bit flo t
150	L1 I Harmonics 51	Phase1 current 51st harmonic	RO	%	32 bit flo t
PHASE 2					
152	L2 V	Phase2 voltage	RO	V	32 bit flo t
154	L2 I	Phase2 current	RO	A	32 bit flo t
156	L2 P	Phase2 active power	RO	W	32 bit flo t
158	L2 Q	Phase2 reactive power	RO	VAr	32 bit flo t
160	L2 S	Phase2 apparent power	RO	VA	32 bit flo t
162	L2 CosØ	Phase2 CosØ	RO	-	32 bit flo t
164	L2 PF	Phase2 power factor	RO	-	32 bit flo t

Address	Parameter	Description	R/W	Unit	Data Type
166	L2 F	Phase2 frequency	RO	Hz	32 bit flo t
168	L2 THDV	Phase2 total har. distortion of voltage	RO	%	32 bit flo t
170	L2 THDI	Phase2 total har. distortion of current	RO	%	32 bit flo t
172	L2 V Harmonics 1	Phase2 voltage first harmonic	RO	%	32 bit flo t
174	L2 V Harmonics 3	Phase2 voltage third harmonic	RO	%	32 bit flo t
176	L2 V Harmonics 5	Phase2 voltage 5th harmonic	RO	%	32 bit flo t
178	L2 V Harmonics 7	Phase2 voltage 7th harmonic	RO	%	32 bit flo t
180	L2 V Harmonics 9	Phase2 voltage 9th harmonic	RO	%	32 bit flo t
182	L2 V Harmonics 11	Phase2 voltage 11th harmonic	RO	%	32 bit flo t
184	L2 V Harmonics 13	Phase2 voltage 13th harmonic	RO	%	32 bit flo t
186	L2 V Harmonics 15	Phase2 voltage 15th harmonic	RO	%	32 bit flo t
188	L2 V Harmonics 17	Phase2 voltage 17th harmonic	RO	%	32 bit flo t
190	L2 V Harmonics 19	Phase2 voltage 19th harmonic	RO	%	32 bit flo t
192	L2 V Harmonics 21	Phase2 voltage 21st harmonic	RO	%	32 bit flo t
194	L2 V Harmonics 23	Phase2 voltage 23rd harmonic	RO	%	32 bit flo t
196	L2 V Harmonics 25	Phase2 voltage 25th harmonic	RO	%	32 bit flo t
198	L2 V Harmonics 27	Phase2 voltage 27th harmonic	RO	%	32 bit flo t
200	L2 V Harmonics 29	Phase2 voltage 29th harmonic	RO	%	32 bit flo t
202	L2 V Harmonics 31	Phase2 voltage 31st harmonic	RO	%	32 bit flo t
204	L2 V Harmonics 33	Phase2 voltage 33rd harmonic	RO	%	32 bit flo t
206	L2 V Harmonics 35	Phase2 voltage 35th harmonic	RO	%	32 bit flo t
208	L2 V Harmonics 37	Phase2 voltage 37th harmonic	RO	%	32 bit flo t
210	L2 V Harmonics 39	Phase2 voltage 39th harmonic	RO	%	32 bit flo t
212	L2 V Harmonics 41	Phase2 voltage 41st harmonic	RO	%	32 bit flo t
214	L2 V Harmonics 43	Phase2 voltage 43rd harmonic	RO	%	32 bit flo t
216	L2 V Harmonics 45	Phase2 voltage 45th harmonic	RO	%	32 bit flo t
218	L2 V Harmonics 47	Phase2 voltage 47th harmonic	RO	%	32 bit flo t
220	L2 V Harmonics 49	Phase2 voltage 49th harmonic	RO	%	32 bit flo t
222	L2 V Harmonics 51	Phase2 voltage 51st harmonic	RO	%	32 bit flo t
224	L2 I Harmonics 1	Phase2 current first harmonic	RO	%	32 bit flo t
226	L2 I Harmonics 3	Phase2 current third harmonic	RO	%	32 bit flo t
228	L2 I Harmonics 5	Phase2 current 5th harmonic	RO	%	32 bit flo t
230	L2 I Harmonics 7	Phase2 current 7th harmonic	RO	%	32 bit flo t
232	L2 I Harmonics 9	Phase2 current 9th harmonic	RO	%	32 bit flo t
234	L2 I Harmonics 11	Phase2 current 11th harmonic	RO	%	32 bit flo t
236	L2 I Harmonics 13	Phase2 current 13th harmonic	RO	%	32 bit flo t
238	L2 I Harmonics 15	Phase2 current 15th harmonic	RO	%	32 bit flo t
240	L2 I Harmonics 17	Phase2 current 17th harmonic	RO	%	32 bit flo t
242	L2 I Harmonics 19	Phase2 current 19th harmonic	RO	%	32 bit flo t
244	L2 I Harmonics 21	Phase2 current 21st harmonic	RO	%	32 bit flo t
246	L2 I Harmonics 23	Phase2 current 23rd harmonic	RO	%	32 bit flo t
248	L2 I Harmonics 25	Phase2 current 25th harmonic	RO	%	32 bit flo t
250	L2 I Harmonics 27	Phase2 current 27th harmonic	RO	%	32 bit flo t
252	L2 I Harmonics 29	Phase2 current 29th harmonic	RO	%	32 bit flo t

Address	Parameter	Description	R/W	Unit	Data Type
254	L2 I Harmonics 31	Phase2 current 31st harmonic	RO	%	32 bit flo t
256	L2 I Harmonics 33	Phase2 current 33rd harmonic	RO	%	32 bit flo t
258	L2 I Harmonics 35	Phase2 current 35th harmonic	RO	%	32 bit flo t
260	L2 I Harmonics 37	Phase2 current 37th harmonic	RO	%	32 bit flo t
262	L2 I Harmonics 39	Phase2 current 39th harmonic	RO	%	32 bit flo t
264	L2 I Harmonics 41	Phase2 current 41st harmonic	RO	%	32 bit flo t
266	L2 I Harmonics 43	Phase2 current 43rd harmonic	RO	%	32 bit flo t
268	L2 I Harmonics 45	Phase2 current 45th harmonic	RO	%	32 bit flo t
270	L2 I Harmonics 47	Phase2 current 47th harmonic	RO	%	32 bit flo t
272	L2 I Harmonics 49	Phase2 current 49th harmonic	RO	%	32 bit flo t
274	L2 I Harmonics 51	Phase2 current 51st harmonic	RO	%	32 bit flo t
PHASE 3					
276	L3 V	Phase3 voltage	RO	V	32 bit flo t
278	L3 I	Phase3 current	RO	A	32 bit flo t
280	L3 P	Phase3 active power	RO	W	32 bit flo t
282	L3 Q	Phase3 reactive power	RO	VAr	32 bit flo t
284	L3 S	Phase3 apparent power	RO	VA	32 bit flo t
286	L3 CosØ	Phase3 CosØ	RO	-	32 bit flo t
288	L3 PF	Phase3 power factor	RO	-	32 bit flo t
290	L3 F	Phase3 frequency	RO	Hz	32 bit flo t
292	L3 THDV	Phase3 total har. distortion of voltage	RO	%	32 bit flo t
294	L3 THDI	Phase3 total har. distortion of current	RO	%	32 bit flo t
296	L3 V Harmonics 1	Phase3 voltage first harmonic	RO	%	32 bit flo t
298	L3 V Harmonics 3	Phase3 voltage third harmonic	RO	%	32 bit flo t
300	L3 V Harmonics 5	Phase3 voltage 5th harmonic	RO	%	32 bit flo t
302	L3 V Harmonics 7	Phase3 voltage 7th harmonic	RO	%	32 bit flo t
304	L3 V Harmonics 9	Phase3 voltage 9th harmonic	RO	%	32 bit flo t
306	L3 V Harmonics 11	Phase3 voltage 11th harmonic	RO	%	32 bit flo t
308	L3 V Harmonics 13	Phase3 voltage 13th harmonic	RO	%	32 bit flo t
310	L3 V Harmonics 15	Phase3 voltage 15th harmonic	RO	%	32 bit flo t
312	L3 V Harmonics 17	Phase3 voltage 17th harmonic	RO	%	32 bit flo t
314	L3 V Harmonics 19	Phase3 voltage 19th harmonic	RO	%	32 bit flo t
316	L3 V Harmonics 21	Phase3 voltage 21st harmonic	RO	%	32 bit flo t
318	L3 V Harmonics 23	Phase3 voltage 23rd harmonic	RO	%	32 bit flo t
320	L3 V Harmonics 25	Phase3 voltage 25th harmonic	RO	%	32 bit flo t
322	L3 V Harmonics 27	Phase3 voltage 27th harmonic	RO	%	32 bit flo t
324	L3 V Harmonics 29	Phase3 voltage 29th harmonic	RO	%	32 bit flo t
326	L3 V Harmonics 31	Phase3 voltage 31st harmonic	RO	%	32 bit flo t
328	L3 V Harmonics 33	Phase3 voltage 33rd harmonic	RO	%	32 bit flo t
330	L3 V Harmonics 35	Phase3 voltage 35th harmonic	RO	%	32 bit flo t
332	L3 V Harmonics 37	Phase3 voltage 37th harmonic	RO	%	32 bit flo t
334	L3 V Harmonics 39	Phase3 voltage 39th harmonic	RO	%	32 bit flo t
336	L3 V Harmonics 41	Phase3 voltage 41st harmonic	RO	%	32 bit flo t
338	L3 V Harmonics 43	Phase3 voltage 43rd harmonic	RO	%	32 bit flo t

Address	Parameter	Description	R/W	Unit	Data Type
340	L3 V Harmonics 45	Phase3 voltage 45th harmonic	RO	%	32 bit flo t
342	L3 V Harmonics 47	Phase3 voltage 47th harmonic	RO	%	32 bit flo t
344	L3 V Harmonics 49	Phase3 voltage 49th harmonic	RO	%	32 bit flo t
346	L3 V Harmonics 51	Phase3 voltage 51st harmonic	RO	%	32 bit flo t
348	L3 I Harmonics 1	Phase3 current first harmonic	RO	%	32 bit flo t
350	L3 I Harmonics 3	Phase3 current third harmonic	RO	%	32 bit flo t
352	L3 I Harmonics 5	Phase3 current 5th harmonic	RO	%	32 bit flo t
354	L3 I Harmonics 7	Phase3 current 7th harmonic	RO	%	32 bit flo t
356	L3 I Harmonics 9	Phase3 current 9th harmonic	RO	%	32 bit flo t
358	L3 I Harmonics 11	Phase3 current 11th harmonic	RO	%	32 bit flo t
360	L3 I Harmonics 13	Phase3 current 13th harmonic	RO	%	32 bit flo t
362	L3 I Harmonics 15	Phase3 current 15th harmonic	RO	%	32 bit flo t
364	L3 I Harmonics 17	Phase3 current 17th harmonic	RO	%	32 bit flo t
366	L3 I Harmonics 19	Phase3 current 19th harmonic	RO	%	32 bit flo t
368	L3 I Harmonics 21	Phase3 current 21st harmonic	RO	%	32 bit flo t
370	L3 I Harmonics 23	Phase3 current 23rd harmonic	RO	%	32 bit flo t
372	L3 I Harmonics 25	Phase3 current 25th harmonic	RO	%	32 bit flo t
374	L3 I Harmonics 27	Phase3 current 27th harmonic	RO	%	32 bit flo t
376	L3 I Harmonics 29	Phase3 current 29th harmonic	RO	%	32 bit flo t
378	L3 I Harmonics 31	Phase3 current 31st harmonic	RO	%	32 bit flo t
380	L3 I Harmonics 33	Phase3 current 33rd harmonic	RO	%	32 bit flo t
382	L3 I Harmonics 35	Phase3 current 35th harmonic	RO	%	32 bit flo t
384	L3 I Harmonics 37	Phase3 current 37th harmonic	RO	%	32 bit flo t
386	L3 I Harmonics 39	Phase3 current 39th harmonic	RO	%	32 bit flo t
388	L3 I Harmonics 41	Phase3 current 41st harmonic	RO	%	32 bit flo t
390	L3 I Harmonics 43	Phase3 current 43rd harmonic	RO	%	32 bit flo t
392	L3 I Harmonics 45	Phase3 current 45th harmonic	RO	%	32 bit flo t
394	L3 I Harmonics 47	Phase3 current 47th harmonic	RO	%	32 bit flo t
396	L3 I Harmonics 49	Phase3 current 49th harmonic	RO	%	32 bit flo t
398	L3 I Harmonics 51	Phase3 current 51st harmonic	RO	%	32 bit flo t
ALARM FLAGS					
400	Alarms 1	Alarm flag 1 (first 32 bit	RO	-	32 bit int.
402	Alarms 2	Alarm flag 2 (se ond 32 bit)	RO	-	32 bit int.
STEP VARIABLES					
404	Active step	Active step flag	RO	-	32 bit int.
406	Available step	Available step flag	RO	-	32 bit int.
408	Fixed step	Fixed step flag	RO	-	32 bit int.
410	S1 switching count	Step 1 switching count	RO	-	32 bit int.
412	S2 switching count	Step 2 switching count	RO	-	32 bit int.
414	S3 switching count	Step 3 switching count	RO	-	32 bit int.
416	S4 switching count	Step 4 switching count	RO	-	32 bit int.
418	S5 switching count	Step 5 switching count	RO	-	32 bit int.
420	S6 switching count	Step 6 switching count	RO	-	32 bit int.
422	S7 switching count	Step 7 switching count	RO	-	32 bit int.

Address	Parameter	Description	R/W	Unit	Data Type
424	S8 switching count	Step 8 switching count	RO	-	32 bit int.
426	S9 switching count	Step 9 switching count	RO	-	32 bit int.
428	S10 switching count	Step 10 switching count	RO	-	32 bit int.
430	S11 switching count	Step 11 switching count	RO	-	32 bit int.
432	S12 switching count	Step 12 switching count	RO	-	32 bit int.
434	S1 operation time	Step 1 operation time	RO	min.	32 bit int.
436	S2 operation time	Step 2 operation time	RO	min.	32 bit int.
438	S3 operation time	Step 3 operation time	RO	min.	32 bit int.
440	S4 operation time	Step 4 operation time	RO	min.	32 bit int.
442	S5 operation time	Step 5 operation time	RO	min.	32 bit int.
444	S6 operation time	Step 6 operation time	RO	min.	32 bit int.
446	S7 operation time	Step 7 operation time	RO	min.	32 bit int.
448	S8 operation time	Step 8 operation time	RO	min.	32 bit int.
450	S9 operation time	Step 9 operation time	RO	min.	32 bit int.
452	S10 operation time	Step 10 operation time	RO	min.	32 bit int.
454	S11 operation time	Step 11 operation time	RO	min.	32 bit int.
456	S12 operation time	Step 12 operation time	RO	min.	32 bit int.
ENERGY METERS (32 bit)					
458	T1 Imp. Act. Index	Tariff 1 mport Active Index	RO	kWh	32 bit flo t
460	T1 Imp. Act. Curr. Hour	Tariff 1 mport Active Current Hour	RO	kWh	32 bit flo t
462	T1 Imp. Act. Prev. Hour	Tariff 1 mport Active Previous Hour	RO	kWh	32 bit flo t
464	T1 Imp. Act. Curr. Day	Tariff 1 mport. Active Current Day	RO	kWh	32 bit flo t
466	T1 Imp. Act. Prev. Day	Tariff 1 mport Active Previous Day	RO	kWh	32 bit flo t
468	T1 Imp. Act. Curr. Month	Tariff 1 mport Active Current Month	RO	kWh	32 bit flo t
470	T1 Imp. Act. Prev. Month	Tariff 1 mport Previous Month	RO	kWh	32 bit flo t
472	T1 Exp. Act. Index	Tariff 1 Expo t Active Index	RO	kWh	32 bit flo t
474	T1 Exp. Act. Curr. Hour	Tariff 1 Expo t Active Current Hour	RO	kWh	32 bit flo t
476	T1 Exp. Act. Prev. Hour	Tariff 1 Expo t Active Previous Hour	RO	kWh	32 bit flo t
478	T1 Exp. Act. Curr. Day	Tariff 1 Expo t Active Current Day	RO	kWh	32 bit flo t
480	T1 Exp. Act. Prev. Day	Tariff 1 Expo t Active Previous Day	RO	kWh	32 bit flo t
482	T1 Exp. Act. Curr. Month	Tariff 1 Expo t Active Current Month	RO	kWh	32 bit flo t
484	T1 Exp. Act. Prev. Month	Tariff 1 Expo t Active Previous Month	RO	kWh	32 bit flo t
486	T1 Ind. React. Index	Tariff 1 nductive Reactive Index	RO	kVArh	32 bit flo t
488	T1 Ind. React. Curr. Hour	Tariff 1 nductive Reactive Current Hour	RO	kVArh	32 bit flo t
490	T1 Ind. React. Prev. Hour	Tariff 1 nductive Reactive Previous Hour	RO	kVArh	32 bit flo t
492	T1 Ind. React. Curr. Day	Tariff 1 nductive Reactive Current Day	RO	kVArh	32 bit flo t
494	T1 Ind. React. Prev. Day	Tariff 1 nductive Reactive Previous Day	RO	kVArh	32 bit flo t
496	T1 Ind. React. Curr. Month	Tariff 1 nductive Reactive Current Month	RO	kVArh	32 bit flo t
498	T1 Ind. React. Prev. Month	Tariff 1 nductive Reactive Previous Month	RO	kVArh	32 bit flo t
500	T1 Cap. React. Index	Tariff 1 apacitive Reactive Index	RO	kVArh	32 bit flo t
502	T1 Cap. React. Curr. Hour	Tariff 1 apacitive Reactive Current Hour	RO	kVArh	32 bit flo t
504	T1 Cap. React. Prev. Hour	Tariff 1 apacitive Reactive Previous Hour	RO	kVArh	32 bit flo t
506	T1 Cap. React. Curr. Day	Tariff 1 apacitive Reactive Current Day	RO	kVArh	32 bit flo t
508	T1 Cap. React. Prev. Day	Tariff 1 apacitive Reactive Previous Day	RO	kVArh	32 bit flo t

Address	Parameter	Description	R/W	Unit	Data Type
510	T1 Cap. React. Curr. Month	Tariff 1 apacitive Reactive Current Month	RO	kVArh	32 bit flo t
512	T1 Cap. React. Prev. Month	Tariff 1 apacitive Reactive Previous Month	RO	kVArh	32 bit flo t
DEMAND					
514	Curr. Month P tot.	Current Month Total Active Power	RO	W	32 bit flo t
516	Curr. Month P tot. time	Current Month Total Active Power Timestamp	RO	-	32 bit unix time
518	Curr. Month I tot.	Current Month Total Current	RO	A	32 bit flo t
520	Curr. Month I tot. time	Current Month Total Current Timestamp	RO	-	32 bit unix time
522	Curr. Month Q tot.	Current Month Total Reactive Power	RO	VAr	32 bit flo t
524	Curr. Month Q tot. time	Current Month Total Reactive Power Timestamp	RO	-	32 bit unix time
526	Curr. Month S tot.	Current Month Total Apparent Power	RO	VA	32 bit flo t
528	Curr. Month S tot. time	Current Month Total Apparent Power Timestamp	RO	-	32 bit unix time
530	Curr. Month L1 P	Current Month Phase 1 Active Power	RO	W	32 bit flo t
532	Curr. Month L1 P time	Current Month Phase 1 Active Power Timestamp	RO	-	32 bit unix time
534	Curr. Month L1 I	Current Month Phase 1 Current	RO	A	32 bit flo t
536	Curr. Month L1 I time	Current Month Phase 1 Current Timestamp	RO	-	32 bit unix time
538	Curr. Month L1 Q	Current Month Phase 1 Reactive Power	RO	VAr	32 bit flo t
540	Curr. Month L1 Q time	Current Month Phase 1 Reactive Power Timestamp	RO	-	32 bit unix time
542	Curr. Month L1 S	Current Month Phase 1 Apparent Power	RO	VA	32 bit flo t
544	Curr. Month L1 S time	Current Month Phase 1 Apparent Power Timestamp	RO	-	32 bit unix time
546	Curr. Month L2 P	Current Month Phase 2 Active Power	RO	W	32 bit flo t
548	Curr. Month L2 P time	Current Month Phase 2 Active Power Timestamp	RO	-	32 bit unix time
550	Curr. Month L2 I	Current Month Phase 2 Current	RO	A	32 bit flo t
552	Curr. Month L2 I time	Current Month Phase 2 Current Timestamp	RO	-	32 bit unix time
554	Curr. Month L2 Q	Current Month Phase 2 Reactive Power	RO	VAr	32 bit flo t
556	Curr. Month L2 Q time	Current Month Phase 2 Reactive Power Timestamp	RO	-	32 bit unix time
558	Curr. Month L2 S	Current Month Phase 2 Apparent Power	RO	VA	32 bit flo t
560	Curr. Month L2 S time	Current Month Phase 2 Apparent Power Timestamp	RO	-	32 bit unix time
562	Curr. Month L3 P	Current Month Phase 3 Active Power	RO	W	32 bit flo t
564	Curr. Month L3 P time	Current Month Phase 3 Active Power Timestamp	RO	-	32 bit unix time
566	Curr. Month L3 I	Current Month Phase 3 Current	RO	A	32 bit flo t
568	Curr. Month L3 I time	Current Month Phase 3 Current Timestamp	RO	-	32 bit unix time
570	Curr. Month L3 Q	Current Month Phase 3 Reactive Power	RO	VAr	32 bit flo t
572	Curr. Month L3 Q time	Current Month Phase 3 Reactive Power Timestamp	RO	-	32 bit unix time
574	Curr. Month L3 S	Current Month Phase 3 Apparent Power	RO	VA	32 bit flo t
576	Curr. Month L3 S time	Current Month Phase 3 Apparent Power Timestamp	RO	-	32 bit unix time

Address	Parameter	Description	R/W	Unit	Data Type
OTHER					
578	Temp.	Temperature Value	RO	°C	32 bit flo t
580	Battery Voltage	-	RO	V	32 bit flo t
582	Time	System Date and Time	R/W	-	32 bit unix time
ALARM STATUSES					
584	1 - Alarm Timestamp	1 - Alarm time	RO	-	32 bit unix time
586	1 - Alarm ID	1 - Alarm ID	RO	-	32 bit int.
588	1 - Alarm Status	1 - Alarm ON /Alarm OFF status	RO	-	32 bit int.
590	1 - Alarm Value	1 - Value of related alarm parameter	RO	-	32 bit flo t
592	2 - Alarm Timestamp	2 - Alarm time	RO	-	32 bit unix time
594	2 - Alarm ID	2 - Alarm ID	RO	-	32 bit int.
596	2 - Alarm Status	2 - Alarm ON /Alarm OFF status	RO	-	32 bit int.
598	2 - Alarm Value	2 - Value of related alarm parameter	RO	-	32 bit flo t
600	3 - Alarm Timestamp	3 - Alarm time	RO	-	32 bit unix time
602	3 - Alarm ID	3 - Alarm ID	RO	-	32 bit int.
604	3 - Alarm Status	3 - Alarm ON /Alarm OFF status	RO	-	32 bit int.
606	3 - Alarm Value	3 - Value of related alarm parameter	RO	-	32 bit flo t
608	4 - Alarm Timestamp	4 - Alarm time	RO	-	32 bit unix time
610	4 - Alarm ID	4 - Alarm ID	RO	-	32 bit int.
612	4 - Alarm Status	4 - Alarm ON /Alarm OFF status	RO	-	32 bit int.
614	4 - Alarm Value	4 - Value of related alarm parameter	RO	-	32 bit flo t
616	5 - Alarm Timestamp	5 - Alarm time	RO	-	32 bit unix time
618	5 - Alarm ID	5 - Alarm ID	RO	-	32 bit int.
620	5 - Alarm Status	5 - Alarm ON /Alarm OFF status	RO	-	32 bit int.
622	5 - Alarm Value	5 - Value of related alarm parameter	RO	-	32 bit flo t
624	6 - Alarm Timestamp	6 - Alarm time	RO	-	32 bit unix time
626	6 - Alarm ID	6 - Alarm ID	RO	-	32 bit int.
628	6 - Alarm Status	6 - Alarm ON /Alarm OFF status	RO	-	32 bit int.
630	6 - Alarm Value	6 - Value of related alarm parameter	RO	-	32 bit flo t
632	7 - Alarm Timestamp	7 - Alarm time	RO	-	32 bit unix time
634	7 - Alarm ID	7 - Alarm ID	RO	-	32 bit int.
636	7 - Alarm Status	7 - Alarm ON /Alarm OFF status	RO	-	32 bit int.
638	7 - Alarm Value	7 - Value of related alarm parameter	RO	-	32 bit flo t
640	8 - Alarm Timestamp	8 - Alarm time	RO	-	32 bit unix time
642	8 - Alarm ID	8 - Alarm ID	RO	-	32 bit int.
644	8 - Alarm Status	8 - Alarm ON /Alarm OFF status	RO	-	32 bit int.
646	8 - Alarm Value	8 - Value of related alarm parameter	RO	-	32 bit flo t
648	9 - Alarm Timestamp	9 - Alarm time	RO	-	32 bit unix time
650	9 - Alarm ID	9 - Alarm ID	RO	-	32 bit int.
652	9 - Alarm Status	9 - Alarm ON /Alarm OFF status	RO	-	32 bit int.
654	9 - Alarm Value	9 - Value of related alarm parameter	RO	-	32 bit flo t
656	10 - Alarm Timestamp	10 - Alarm time	RO	-	32 bit unix time
658	10 - Alarm ID	10 - Alarm ID	RO	-	32 bit int.
660	10 - Alarm Status	10 - Alarm ON /Alarm OFF status	RO	-	32 bit int.

Address	Parameter	Description	R/W	Unit	Data Type
662	10 - Alarm Value	10 - Value of related alarm parameter	RO	-	32 bit flo t
664	11 - Alarm Timestamp	11 - Alarm time	RO	-	32 bit unix time
666	11 - Alarm ID	11 - Alarm ID	RO	-	32 bit int.
668	11 - Alarm Status	11 - Alarm ON /Alarm OFF status	RO	-	32 bit int.
670	11 - Alarm Value	11 - Value of related alarm parameter	RO	-	32 bit flo t
672	12 - Alarm Timestamp	12 - Alarm time	RO	-	32 bit unix time
674	12 - Alarm ID	12 - Alarm ID	RO	-	32 bit int.
676	12 - Alarm Status	12 - Alarm ON /Alarm OFF status	RO	-	32 bit int.
678	12 - Alarm Value	12 - Value of related alarm parameter	RO	-	32 bit flo t
680	13 - Alarm Timestamp	13 - Alarm time	RO	-	32 bit unix time
682	13 - Alarm ID	13 - Alarm ID	RO	-	32 bit int.
684	13 - Alarm Status	13 - Alarm ON /Alarm OFF status	RO	-	32 bit int.
686	13 - Alarm Value	13 - Value of related alarm parameter	RO	-	32 bit flo t
688	14 - Alarm Timestamp	14 - Alarm time	RO	-	32 bit unix time
690	14 - Alarm ID	14 - Alarm ID	RO	-	32 bit int.
692	14 - Alarm Status	14 - Alarm ON /Alarm OFF status	RO	-	32 bit int.
694	14 - Alarm Value	14 - Value of related alarm parameter	RO	-	32 bit flo t
696	15 - Alarm Timestamp	15 - Alarm zaman değeri	RO	-	32 bit unix time
698	15 - Alarm ID	15 - Alarm ID	RO	-	32 bit int.
700	15 - Alarm Status	15 - Alarm ON /Alarm OFF status	RO	-	32 bit int.
702	15 - Alarm Value	15 - Value of related alarm parameter	RO	-	32 bit flo t
704	16 - Alarm Timestamp	16 - Alarm time	RO	-	32 bit unix time
706	16 - Alarm ID	16 - Alarm ID	RO	-	32 bit int.
708	16 - Alarm Status	16 - Alarm ON /Alarm OFF status	RO	-	32 bit int.
710	16 - Alarm Value	16 - Value of related alarm parameter	RO	-	32 bit flo t
712	17 - Alarm Timestamp	17 - Alarm time	RO	-	32 bit unix time
714	17 - Alarm ID	17 - Alarm ID	RO	-	32 bit int.
716	17 - Alarm Status	17 - Alarm ON /Alarm OFF status	RO	-	32 bit int.
718	17 - Alarm Value	17 - Value of related alarm parameter	RO	-	32 bit flo t
720	18 - Alarm Timestamp	18 - Alarm time	RO	-	32 bit unix time
722	18 - Alarm ID	18 - Alarm ID	RO	-	32 bit int.
724	18 - Alarm Status	18 - Alarm ON /Alarm OFF status	RO	-	32 bit int.
726	18 - Alarm Value	18 - Value of related alarm parameter	RO	-	32 bit flo t
728	19 - Alarm Timestamp	19 - Alarm time	RO	-	32 bit unix time
730	19 - Alarm ID	19 - Alarm ID	RO	-	32 bit int.
732	19 - Alarm Status	19 - Alarm ON /Alarm OFF status	RO	-	32 bit int.
734	19 - Alarm Value	19 - Value of related alarm parameter	RO	-	32 bit flo t
736	20 - Alarm Timestamp	20 - Alarm time	RO	-	32 bit unix time
738	20 - Alarm ID	20 - Alarm ID	RO	-	32 bit int.
740	20 - Alarm Status	20 - Alarm ON /Alarm OFF status	RO	-	32 bit int.
742	20 - Alarm Value	20 - Value of related alarm parameter	RO	-	32 bit flo t
744	21 - Alarm Timestamp	21 - Alarm time	RO	-	32 bit unix time
746	21 - Alarm ID	21 - Alarm ID	RO	-	32 bit int.
748	21 - Alarm Status	21 - Alarm ON /Alarm OFF status	RO	-	32 bit int.

Address	Parameter	Description	R/W	Unit	Data Type
750	21 - Alarm Value	21 - Value of related alarm parameter	RO	-	32 bit flo t
752	22 - Alarm Timestamp	22 - Alarm time	RO	-	32 bit unix time
754	22 - Alarm ID	22 - Alarm ID	RO	-	32 bit int.
756	22 - Alarm Status	22 - Alarm ON /Alarm OFF status	RO	-	32 bit int.
758	22 - Alarm Value	22 - Value of related alarm parameter	RO	-	32 bit flo t
760	23 - Alarm Timestamp	23 - Alarm time	RO	-	32 bit unix time
762	23 - Alarm ID	23 - Alarm ID	RO	-	32 bit int.
764	23 - Alarm Status	23 - Alarm ON /Alarm OFF status	RO	-	32 bit int.
766	23 - Alarm Value	23 - Value of related alarm parameter	RO	-	32 bit flo t
768	24 - Alarm Timestamp	24 - Alarm time	RO	-	32 bit unix time
770	24 - Alarm ID	24 - Alarm ID	RO	-	32 bit int.
772	24 - Alarm Status	24 - Alarm ON /Alarm OFF status	RO	-	32 bit int.
774	24 - Alarm Value	24 - Value of related alarm parameter	RO	-	32 bit flo t
776	25 - Alarm Timestamp	25 - Alarm time	RO	-	32 bit unix time
778	25 - Alarm ID	25 - Alarm ID	RO	-	32 bit int.
780	25 - Alarm Status	25 - Alarm ON /Alarm OFF status	RO	-	32 bit int.
782	25 - Alarm Value	25 - Value of related alarm parameter	RO	-	32 bit flo t
784	26 - Alarm Timestamp	26 - Alarm time	RO	-	32 bit unix time
786	26 - Alarm ID	26 - Alarm ID	RO	-	32 bit int.
788	26 - Alarm Status	26 - Alarm ON /Alarm OFF status	RO	-	32 bit int.
790	26 - Alarm Value	26 - Value of related alarm parameter	RO	-	32 bit flo t
792	27 - Alarm Timestamp	27 - Alarm time	RO	-	32 bit unix time
794	27 - Alarm ID	27 - Alarm ID	RO	-	32 bit int.
796	27 - Alarm Status	27 - Alarm ON /Alarm OFF status	RO	-	32 bit int.
798	27 - Alarm Value	27 - Value of related alarm parameter	RO	-	32 bit flo t
800	28 - Alarm Timestamp	28 - Alarm time	RO	-	32 bit unix time
802	28 - Alarm ID	28 - Alarm ID	RO	-	32 bit int.
804	28 - Alarm Status	28 - Alarm ON /Alarm OFF status	RO	-	32 bit int.
806	28 - Alarm Value	28 - Value of related alarm parameter	RO	-	32 bit flo t
808	29 - Alarm Timestamp	29 - Alarm time	RO	-	32 bit unix time
810	29 - Alarm ID	29 - Alarm ID	RO	-	32 bit int.
812	29 - Alarm Status	29 - Alarm ON /Alarm OFF status	RO	-	32 bit int.
814	29 - Alarm Value	29 - Value of related alarm parameter	RO	-	32 bit flo t
816	30 - Alarm Timestamp	30 - Alarm time	RO	-	32 bit unix time
818	30 - Alarm ID	30 - Alarm ID	RO	-	32 bit int.
820	30 - Alarm Status	30 - Alarm ON /Alarm OFF status	RO	-	32 bit int.
822	30 - Alarm Value	30 - Value of related alarm parameter	RO	-	32 bit flo t
824	31 - Alarm Timestamp	31 - Alarm time	RO	-	32 bit unix time
826	31 - Alarm ID	31 - Alarm ID	RO	-	32 bit int.
828	31 - Alarm Status	31 - Alarm ON /Alarm OFF status	RO	-	32 bit int.
830	31 - Alarm Value	31 - Value of related alarm parameter	RO	-	32 bit flo t
832	31 - Alarm Timestamp	32 - Alarm time	RO	-	32 bit unix time
834	32 - Alarm ID	32 - Alarm ID	RO	-	32 bit int.
836	32 - Alarm Status	32 - Alarm ON /Alarm OFF status	RO	-	32 bit int.

Address	Parameter	Description	R/W	Unit	Data Type
838	32 - Alarm Value	32 - Value of related alarm parameter	RO	-	32 bit flo t
840	33 - Alarm Timestamp	33 - Alarm time	RO	-	32 bit unix time
842	33 - Alarm ID	33 - Alarm ID	RO	-	32 bit int.
844	33 - Alarm Status	33 - Alarm ON /Alarm OFF status	RO	-	32 bit int.
846	33 - Alarm Value	33 - Value of related alarm parameter	RO	-	32 bit flo t
848	34 - Alarm Timestamp	34 - Alarm time	RO	-	32 bit unix time
850	34 - Alarm ID	34 - Alarm ID	RO	-	32 bit int.
852	34 - Alarm Status	34 - Alarm ON /Alarm OFF status	RO	-	32 bit int.
854	34 - Alarm Value	34 - Value of related alarm parameter	RO	-	32 bit flo t
856	35 - Alarm Timestamp	35 - Alarm time	RO	-	32 bit unix time
858	35 - Alarm ID	35 - Alarm ID	RO	-	32 bit int.
860	35 - Alarm Status	35 - Alarm ON /Alarm OFF status	RO	-	32 bit int.
862	35 - Alarm Value	35 - Value of related alarm parameter	RO	-	32 bit flo t
864	36 - Alarm Timestamp	36 - Alarm time	RO	-	32 bit unix time
866	36 - Alarm ID	36 - Alarm ID	RO	-	32 bit int.
868	36 - Alarm Status	36 - Alarm ON /Alarm OFF status	RO	-	32 bit int.
870	36 - Alarm Value	36 - Value of related alarm parameter	RO	-	32 bit flo t
872	37 - Alarm Timestamp	37 - Alarm time	RO	-	32 bit unix time
874	37 - Alarm ID	37 - Alarm ID	RO	-	32 bit int.
876	37 - Alarm Status	37 - Alarm ON /Alarm OFF status	RO	-	32 bit int.
878	37 - Alarm Value	37 - Value of related alarm parameter	RO	-	32 bit flo t
880	38 - Alarm Timestamp	38 - Alarm time	RO	-	32 bit unix time
882	38 - Alarm ID	38 - Alarm ID	RO	-	32 bit int.
884	38 - Alarm Status	38 - Alarm ON /Alarm OFF status	RO	-	32 bit int.
886	38 - Alarm Value	38 - Value of related alarm parameter	RO	-	32 bit flo t
888	39 - Alarm Timestamp	39 - Alarm time	RO	-	32 bit unix time
890	39 - Alarm ID	39 - Alarm ID	RO	-	32 bit int.
892	39 - Alarm Status	39 - Alarm ON /Alarm OFF status	RO	-	32 bit int.
894	39 - Alarm Value	39 - Value of related alarm parameter	RO	-	32 bit flo t
896	40 - Alarm Timestamp	40 - Alarm time	RO	-	32 bit unix time
898	40 - Alarm ID	40 - Alarm ID	RO	-	32 bit int.
900	40 - Alarm Status	40 - Alarm ON /Alarm OFF status	RO	-	32 bit int.
902	40 - Alarm Value	40 - Value of related alarm parameter	RO	-	32 bit flo t
904	41 - Alarm Timestamp	41 - Alarm time	RO	-	32 bit unix time
906	41 - Alarm ID	41 - Alarm ID	RO	-	32 bit int.
908	41 - Alarm Status	41 - Alarm ON /Alarm OFF status	RO	-	32 bit int.
910	41 - Alarm Value	41 - Value of related alarm parameter	RO	-	32 bit flo t
912	42 - Alarm Timestamp	42 - Alarm time	RO	-	32 bit unix time
914	42 - Alarm ID	42 - Alarm ID	RO	-	32 bit int.
916	42 - Alarm Status	42 - Alarm ON /Alarm OFF status	RO	-	32 bit int.
918	42 - Alarm Value	42 - Value of related alarm parameter	RO	-	32 bit flo t
920	43 - Alarm Timestamp	43 - Alarm time	RO	-	32 bit unix time
922	43 - Alarm ID	43 - Alarm ID	RO	-	32 bit int.
924	43 - Alarm Status	43 - Alarm ON /Alarm OFF status	RO	-	32 bit int.

Address	Parameter	Description	R/W	Unit	Data Type
926	43 - Alarm Value	43 - Value of related alarm parameter	RO	-	32 bit flo t
928	44 - Alarm Timestamp	44 - Alarm time	RO	-	32 bit unix time
930	44 - Alarm ID	44 - Alarm ID	RO	-	32 bit int.
932	44 - Alarm Status	44 - Alarm ON /Alarm OFF status	RO	-	32 bit int.
934	44 - Alarm Value	44 - Value of related alarm parameter	RO	-	32 bit flo t
936	45 - Alarm Timestamp	45 - Alarm time	RO	-	32 bit unix time
938	45 - Alarm ID	45 - Alarm ID	RO	-	32 bit int.
940	45 - Alarm Status	45 - Alarm ON /Alarm OFF status	RO	-	32 bit int.
942	45 - Alarm Value	45 - Value of related alarm parameter	RO	-	32 bit flo t
944	46 - Alarm Timestamp	46 - Alarm time	RO	-	32 bit unix time
946	46 - Alarm ID	46 - Alarm ID	RO	-	32 bit int.
948	46 - Alarm Status	46 - Alarm ON /Alarm OFF status	RO	-	32 bit int.
950	46 - Alarm Value	46 - Value of related alarm parameter	RO	-	32 bit flo t
952	47 - Alarm Timestamp	47 - Alarm time	RO	-	32 bit unix time
954	47 - Alarm ID	47 - Alarm ID	RO	-	32 bit int.
956	47 - Alarm Status	47 - Alarm ON /Alarm OFF status	RO	-	32 bit int.
958	47 - Alarm Value	47 - Value of related alarm parameter	RO	-	32 bit flo t
960	48 - Alarm Timestamp	48 - Alarm time	RO	-	32 bit unix time
962	48 - Alarm ID	48 - Alarm ID	RO	-	32 bit int.
964	48 - Alarm Status	48 - Alarm ON /Alarm OFF status	RO	-	32 bit int.
966	48 - Alarm Value	48 - Value of related alarm parameter	RO	-	32 bit flo t
968	49 - Alarm Timestamp	49 - Alarm time	RO	-	32 bit unix time
970	49 - Alarm ID	49 - Alarm ID	RO	-	32 bit int.
972	49 - Alarm Status	49 - Alarm ON /Alarm OFF status	RO	-	32 bit int.
974	49 - Alarm Value	49 - Value of related alarm parameter	RO	-	32 bit flo t
976	50 - Alarm Timestamp	50 - Alarm time	RO	-	32 bit unix time
978	50 - Alarm ID	50 - Alarm ID	RO	-	32 bit int.
980	50 - Alarm Status	50 - Alarm ON /Alarm OFF status	RO	-	32 bit int.
982	50 - Alarm Value	50 - Value of related alarm parameter	RO	-	32 bit flo t
LAST SAVED FILE NUMBERS					
984	Hourly Archival File Nr.	Latest recorded hourly archival file number	RO	-	32 bit int.
986	Daily Archival File Nr.	Latest recorded daily archival file number	RO	-	32 bit int.
988	Monthly Archival File Nr.	Latest recorded monthly archival file number	RO	-	32 bit int.
ESTIMATED STEP POWERS (DCM Values)					
990	Estimated S1 Power	Estimated Step 1 Power	RO	kVAr	32 bit flo t
992	Estimated S2 Power	Estimated Step 2 Power	RO	kVAr	32 bit flo t
994	Estimated S3 Power	Estimated Step 3 Power	RO	kVAr	32 bit flo t
996	Estimated S4 Power	Estimated Step 4 Power	RO	kVAr	32 bit flo t
998	Estimated S5 Power	Estimated Step 5 Power	RO	kVAr	32 bit flo t
1000	Estimated S6 Power	Estimated Step 6 Power	RO	kVAr	32 bit flo t
1002	Estimated S7 Power	Estimated Step 7 Power	RO	kVAr	32 bit flo t
1004	Estimated S8 Power	Estimated Step 8 Power	RO	kVAr	32 bit flo t
1006	Estimated S9 Power	Estimated Step 9 Power	RO	kVAr	32 bit flo t
1008	Estimated S10 Power	Estimated Step 10 Power	RO	kVAr	32 bit flo t
1010	Estimated S11 Power	Estimated Step 11 Power	RO	kVAr	32 bit flo t
1012	Estimated S12 Power	Estimated Step 12 Power	RO	kVAr	32 bit flo t

Address	Parameter	Description	R/W	Unit	Data Type
GENERATOR INPUT STATUS					
1014	Gen Input	Jenerator Active/Passive Status	RO	-	32 bit flo t
ENERGY METERS (64 bit)					
1016	T1 Imp. Active Index	Tariff 1 mport Active Index	RO	kWh	64 bit double
1020	T1 Exp. Active Index	Tariff 1 Expo tActive Index	RO	kWh	64 bit double
1024	T1 Ind. Reactive Index	Tariff 1 nductive Reactive Index	RO	kVArh	64 bit double
1028	T1 Cap. Reactive Index	Tariff 1 apacitive Reactive Index	RO	kVArh	64 bit double

Unix time: Unix time is the number of seconds elapsed since midnight (00:00) Coordinated Universal Time (UTC) of January 1, 1970, not counting leaps seconds.

NOTE: Tariff Meters’ Index Values can be read in 32 bit and/or 64bit flo ting point format. Mathematically, 64bit flo ting point representation is more accurate than 32 bit flo ting point format.

e.g.

When it is required to read “Tariff 1 mport Active Index” value, it can be received either 32 bit flo ting point format (modbus adr. 458) or in 64 bit flo ting point format (modbus adr.

1016).

If related index value is wanted to read more sensitive, 64bit versions must be selected.

4.5.1.1.1 Alarm Flags(RAPIDUS 231R-E)

Each bit of an alarm flag ariable corresponds to ‘one’ alarm fla .

If any bit’s value is “1”, then there is alarm for that bit. On the contrary, a bit value of “1” means that there is NO alarm for that bit.

The contents of alarm flag ariables are listed below.

Alarms 1

<u>b7</u> THDV1	<u>b6</u> I3	<u>b5</u> I2	<u>b4</u> I1	<u>b3</u> V3	<u>b2</u> V2	<u>b1</u> V1	<u>b0</u> Sic.
<u>b15</u> VLL31	<u>b14</u> VLL23	<u>b13</u> VLL12	<u>b12</u> V3 Harmonics	<u>b11</u> V2 Harmonics	<u>b10</u> V1 Harmonics	<u>b9</u> THDV3	<u>b8</u> THDV2
<u>b23</u> S1	<u>b22</u> Q3	<u>b21</u> Q2	<u>b20</u> Q1	<u>b19</u> P3	<u>b18</u> P2	<u>b17</u> P1	<u>b16</u> IN
<u>b31</u> PF3	<u>b30</u> PF2	<u>b29</u> PF1	<u>b28</u> COSØ3	<u>b27</u> COSØ2	<u>b26</u> COSØ1	<u>b25</u> S3	<u>b24</u> S2

Alarms 2

b7 I2 Harmonics	b6 I1 Harmonics	b5 THDV3	b4 THDV2	b3 THDV1	b2 F3	b1 F2	b0 F1
b15 Step2	b14 Step1	b13 Under Comp.	b12 Over Comp.	b11 Cap. Energy	b10 Ind. Energy	b9 Battery	b8 I3 Harmonics
b23 Step10	b22 Step9	b21 Step8	b20 Step7	b19 Step6	b18 Step5	b17 Step4	b16 Step3
b31 -	b30 -	b29 -	b28 -	b27 -	b26 -	b25 Step12	b24 Step11

Abbreviations used for the Alarm Flags are:

Temp. : Temperature	PF1 : Phase1 Power Factor
V1 : Phase1 (L-N) Voltage	PF2 : Phase2 Power Factor
V2 : Phase2 (L-N) Voltage	PF3 : Phase3 Power Factor
V3 : Phase3 (L-N) Voltage	F1 : Phase1 Frequency
I1 : Phase1 Current	F2 : Phase2 Frequency
I2 : Phase2 Current	F3 : Phase3 Frequency
I3 : Phase3 Current	THDI1 : Phase1 Total Harmonic Distortion in Current
THDV1 : Phase1 Total Harmonic Distortion in Voltage	THDI2 : Phase2 Total Harmonic Distortion in Current
THDV2 : Phase2 Total Harmonic Distortion in Voltage	THDI3 : Phase3 Total Harmonic Distortion in Current
THDV3 : Phase3 Total Harmonic Distortion in Voltage	I1 Harmonics : Phase1 Current Harmonics
V1 Harmonics : Phase1 Voltage Harmonics	I2 Harmonics : Phase2 Current Harmonics
V2 Harmonics : Phase2 Voltage Harmonics	I3 Harmonics : Phase3 Current Harmonics
V3 Harmonics : Phase3 Voltage Harmonics	Battery : Battery Voltage
VLL1 : Phase1-Phase2 Voltage	Ind. Energy : Inductive Energy
VLL2 : Phase2-Phase3 Voltage	Cap. Energy : Capacitive Energy
VLL3 : Phase3-Phase1 Voltage	Over Comp. : Over Compensation
IN : Neutral Current	Under Comp. : Under Compensation
P1 : Phase1 Active Power	Step1 : Step 1 Low Limit Value Alarm
P2 : Phase2 Active Power	Step2 : Step 2 Low Limit Value Alarm
P3 : Phase3 Active Power	Step3 : Step 3 Low Limit Value Alarm
Q1 : Phase1 Reactive Power	Step4 : Step 4 Low Limit Value Alarm
Q2 : Phase2 Reactive Power	Step5 : Step 5 Low Limit Value Alarm
Q3 : Phase3 Reactive Power	Step6 : Step 6 Low Limit Value Alarm
S1 : Phase1 Apparent Power	Step7 : Step 7 Low Limit Value Alarm
S2 : Phase2 Apparent Power	Step8 : Step 8 Low Limit Value Alarm
S3 : Phase3 Apparent Power	Step9 : Step 9 Low Limit Value Alarm
CosØ1 : Phase1 CosØ	Step10 : Step 10 Low Limit Value Alarm
CosØ2 : Phase2 CosØ	Step11 : Step 11 Low Limit Value Alarm
CosØ3 : Phase3 CosØ	Step12 : Step 12 Low Limit Value Alarm



4.5.1.2 Readable Data for RAPIDUS 232R-E

Table 4-5 Readable Data(RAPIDUS 232R-E)

Address	Parameter	Description	R/W	Unit	Data Type
0	V avg.	Average voltage of three phases	RO	V	32 bit flo t
2	I tot.	Total current of three phases	RO	A	32 bit flo t
4	P tot.	Total active power of three phases	RO	W	32 bit flo t
6	Q tot.	Total reactive power of three phases	RO	VAr	32 bit flo t
8	S tot.	Total apparent power of three phases	RO	VA	32 bit flo t
10	CosØ avg.	Average CosØ of three phases	RO	-	32 bit flo t
12	PF avg.	Average PF of three phases	RO	-	32 bit flo t
14	VLL12	Voltage V1-2	RO	V	32 bit flo t
16	VLL23	Voltage V2-3	RO	V	32 bit flo t
18	VLL31	Voltage V3-1	RO	V	32 bit flo t
20	VLL avg.	Average of line to line voltage of three phases	RO	V	32 bit flo t
22	IN	Neutral current	RO	A	32 bit flo t
24	THDV tot.	Total har. distortion of voltage for three phases	RO	%	32 bit flo t
26	THDI tot.	Total har. distortion of voltage for three phases	RO	%	32 bit flo t
PHASE 1					
28	L1 V	Phase1 voltage	RO	V	32 bit flo t
30	L1 I	Phase1 current	RO	A	32 bit flo t
32	L1 P	Phase1 active power	RO	W	32 bit flo t
34	L1 Q	Phase1 reactive power	RO	VAr	32 bit flo t
36	L1 S	Phase1 apparent power	RO	VA	32 bit flo t
38	L1 CosØ	Phase1 CosØ	RO	-	32 bit flo t
40	L1 PF	Phase1 power factor	RO	-	32 bit flo t
42	L1 F	Phase1 frequency	RO	Hz	32 bit flo t
44	L1 THDV	Phase1 total har. distortion of voltage	RO	%	32 bit flo t
46	L1 THDI	Phase1 total har. distortion of current	RO	%	32 bit flo t
48	L1 V Harmonics 1	Phase1 voltage first harmonic	RO	%	32 bit flo t
50	L1 V Harmonics 3	Phase1 voltage third harmonic	RO	%	32 bit flo t
52	L1 V Harmonics 5	Phase1 voltage 5th harmonic	RO	%	32 bit flo t
54	L1 V Harmonics 7	Phase1 voltage 7th harmonic	RO	%	32 bit flo t
56	L1 V Harmonics 9	Phase1 voltage 9th harmonic	RO	%	32 bit flo t
58	L1 V Harmonics 11	Phase1 voltage 11th harmonic	RO	%	32 bit flo t
60	L1 V Harmonics 13	Phase1 voltage 13th harmonic	RO	%	32 bit flo t
62	L1 V Harmonics 15	Phase1 voltage 15th harmonic	RO	%	32 bit flo t
64	L1 V Harmonics 17	Phase1 voltage 17th harmonic	RO	%	32 bit flo t
66	L1 V Harmonics 19	Phase1 voltage 19th harmonic	RO	%	32 bit flo t
68	L1 V Harmonics 21	Phase1 voltage 21st harmonic	RO	%	32 bit flo t
70	L1 V Harmonics 23	Phase1 voltage 23rd harmonic	RO	%	32 bit flo t
72	L1 V Harmonics 25	Phase1 voltage 25th harmonic	RO	%	32 bit flo t
74	L1 V Harmonics 27	Phase1 voltage 27th harmonic	RO	%	32 bit flo t
76	L1 V Harmonics 29	Phase1 voltage 29th harmonic	RO	%	32 bit flo t
78	L1 V Harmonics 31	Phase1 voltage 31st harmonic	RO	%	32 bit flo t

Address	Parameter	Description	R/W	Unit	Data Type
80	L1 V Harmonics 33	Phase1 voltage 33rd harmonic	RO	%	32 bit flo t
82	L1 V Harmonics 35	Phase1 voltage 35th harmonic	RO	%	32 bit flo t
84	L1 V Harmonics 37	Phase1 voltage 37th harmonic	RO	%	32 bit flo t
86	L1 V Harmonics 39	Phase1 voltage 39th harmonic	RO	%	32 bit flo t
88	L1 V Harmonics 41	Phase1 voltage 41st harmonic	RO	%	32 bit flo t
90	L1 V Harmonics 43	Phase1 voltage 43rd harmonic	RO	%	32 bit flo t
92	L1 V Harmonics 45	Phase1 voltage 45th harmonic	RO	%	32 bit flo t
94	L1 V Harmonics 47	Phase1 voltage 47th harmonic	RO	%	32 bit flo t
96	L1 V Harmonics 49	Phase1 voltage 49th harmonic	RO	%	32 bit flo t
98	L1 V Harmonics 51	Phase1 voltage 51st harmonic	RO	%	32 bit flo t
100	L1 I Harmonics 1	Phase1 current first harmonic	RO	%	32 bit flo t
102	L1 I Harmonics 3	Phase1 current third harmonic	RO	%	32 bit flo t
104	L1 I Harmonics 5	Phase1 current 5th harmonic	RO	%	32 bit flo t
106	L1 I Harmonics 7	Phase1 current 7th harmonic	RO	%	32 bit flo t
108	L1 I Harmonics 9	Phase1 current 9th harmonic	RO	%	32 bit flo t
110	L1 I Harmonics 11	Phase1 current 11th harmonic	RO	%	32 bit flo t
112	L1 I Harmonics 13	Phase1 current 13th harmonic	RO	%	32 bit flo t
114	L1 I Harmonics 15	Phase1 current 15th harmonic	RO	%	32 bit flo t
116	L1 I Harmonics 17	Phase1 current 17th harmonic	RO	%	32 bit flo t
118	L1 I Harmonics 19	Phase1 current 19th harmonic	RO	%	32 bit flo t
120	L1 I Harmonics 21	Phase1 current 21st harmonic	RO	%	32 bit flo t
122	L1 I Harmonics 23	Phase1 current 23rd harmonic	RO	%	32 bit flo t
124	L1 I Harmonics 25	Phase1 current 25th harmonic	RO	%	32 bit flo t
126	L1 I Harmonics 27	Phase1 current 27th harmonic	RO	%	32 bit flo t
128	L1 I Harmonics 29	Phase1 current 29th harmonic	RO	%	32 bit flo t
130	L1 I Harmonics 31	Phase1 current 31st harmonic	RO	%	32 bit flo t
132	L1 I Harmonics 33	Phase1 current 33rd harmonic	RO	%	32 bit flo t
134	L1 I Harmonics 35	Phase1 current 35th harmonic	RO	%	32 bit flo t
136	L1 I Harmonics 37	Phase1 current 37th harmonic	RO	%	32 bit flo t
138	L1 I Harmonics 39	Phase1 current 39th harmonic	RO	%	32 bit flo t
140	L1 I Harmonics 41	Phase1 current 41st harmonic	RO	%	32 bit flo t
142	L1 I Harmonics 43	Phase1 current 43rd harmonic	RO	%	32 bit flo t
144	L1 I Harmonics 45	Phase1 current 45th harmonic	RO	%	32 bit flo t
146	L1 I Harmonics 47	Phase1 current 47th harmonic	RO	%	32 bit flo t
148	L1 I Harmonics 49	Phase1 current 49th harmonic	RO	%	32 bit flo t
150	L1 I Harmonics 51	Phase1 current 51st harmonic	RO	%	32 bit flo t
PHASE 2					
152	L2 V	Phase2 voltage	RO	V	32 bit flo t
154	L2 I	Phase2 current	RO	A	32 bit flo t
156	L2 P	Phase2 active power	RO	W	32 bit flo t
158	L2 Q	Phase2 reactive power	RO	VAr	32 bit flo t
160	L2 S	Phase2 apparent power	RO	VA	32 bit flo t
162	L2 CosØ	Phase2 CosØ	RO	-	32 bit flo t
164	L2 PF	Phase2 power factor	RO	-	32 bit flo t

Address	Parameter	Description	R/W	Unit	Data Type
166	L2 F	Phase2 frequency	RO	Hz	32 bit flo t
168	L2 THDV	Phase2 total har. distortion of voltage	RO	%	32 bit flo t
170	L2 THDI	Phase2 total har. distortion of current	RO	%	32 bit flo t
172	L2 V Harmonics 1	Phase2 voltage first harmonic	RO	%	32 bit flo t
174	L2 V Harmonics 3	Phase2 voltage third harmonic	RO	%	32 bit flo t
176	L2 V Harmonics 5	Phase2 voltage 5th harmonic	RO	%	32 bit flo t
178	L2 V Harmonics 7	Phase2 voltage 7th harmonic	RO	%	32 bit flo t
180	L2 V Harmonics 9	Phase2 voltage 9th harmonic	RO	%	32 bit flo t
182	L2 V Harmonics 11	Phase2 voltage 11th harmonic	RO	%	32 bit flo t
184	L2 V Harmonics 13	Phase2 voltage 13th harmonic	RO	%	32 bit flo t
186	L2 V Harmonics 15	Phase2 voltage 15th harmonic	RO	%	32 bit flo t
188	L2 V Harmonics 17	Phase2 voltage 17th harmonic	RO	%	32 bit flo t
190	L2 V Harmonics 19	Phase2 voltage 19th harmonic	RO	%	32 bit flo t
192	L2 V Harmonics 21	Phase2 voltage 21st harmonic	RO	%	32 bit flo t
194	L2 V Harmonics 23	Phase2 voltage 23rd harmonic	RO	%	32 bit flo t
196	L2 V Harmonics 25	Phase2 voltage 25th harmonic	RO	%	32 bit flo t
198	L2 V Harmonics 27	Phase2 voltage 27th harmonic	RO	%	32 bit flo t
200	L2 V Harmonics 29	Phase2 voltage 29th harmonic	RO	%	32 bit flo t
202	L2 V Harmonics 31	Phase2 voltage 31st harmonic	RO	%	32 bit flo t
204	L2 V Harmonics 33	Phase2 voltage 33rd harmonic	RO	%	32 bit flo t
206	L2 V Harmonics 35	Phase2 voltage 35th harmonic	RO	%	32 bit flo t
208	L2 V Harmonics 37	Phase2 voltage 37th harmonic	RO	%	32 bit flo t
210	L2 V Harmonics 39	Phase2 voltage 39th harmonic	RO	%	32 bit flo t
212	L2 V Harmonics 41	Phase2 voltage 41st harmonic	RO	%	32 bit flo t
214	L2 V Harmonics 43	Phase2 voltage 43rd harmonic	RO	%	32 bit flo t
216	L2 V Harmonics 45	Phase2 voltage 45th harmonic	RO	%	32 bit flo t
218	L2 V Harmonics 47	Phase2 voltage 47th harmonic	RO	%	32 bit flo t
220	L2 V Harmonics 49	Phase2 voltage 49th harmonic	RO	%	32 bit flo t
222	L2 V Harmonics 51	Phase2 voltage 51st harmonic	RO	%	32 bit flo t
224	L2 I Harmonics 1	Phase2 current first harmonic	RO	%	32 bit flo t
226	L2 I Harmonics 3	Phase2 current third harmonic	RO	%	32 bit flo t
228	L2 I Harmonics 5	Phase2 current 5th harmonic	RO	%	32 bit flo t
230	L2 I Harmonics 7	Phase2 current 7th harmonic	RO	%	32 bit flo t
232	L2 I Harmonics 9	Phase2 current 9th harmonic	RO	%	32 bit flo t
234	L2 I Harmonics 11	Phase2 current 11th harmonic	RO	%	32 bit flo t
236	L2 I Harmonics 13	Phase2 current 13th harmonic	RO	%	32 bit flo t
238	L2 I Harmonics 15	Phase2 current 15th harmonic	RO	%	32 bit flo t
240	L2 I Harmonics 17	Phase2 current 17th harmonic	RO	%	32 bit flo t
242	L2 I Harmonics 19	Phase2 current 19th harmonic	RO	%	32 bit flo t
244	L2 I Harmonics 21	Phase2 current 21st harmonic	RO	%	32 bit flo t
246	L2 I Harmonics 23	Phase2 current 23rd harmonic	RO	%	32 bit flo t
248	L2 I Harmonics 25	Phase2 current 25th harmonic	RO	%	32 bit flo t
250	L2 I Harmonics 27	Phase2 current 27th harmonic	RO	%	32 bit flo t
252	L2 I Harmonics 29	Phase2 current 29th harmonic	RO	%	32 bit flo t

Address	Parameter	Description	R/W	Unit	Data Type
254	L2 I Harmonics 31	Phase2 current 31st harmonic	RO	%	32 bit flo t
256	L2 I Harmonics 33	Phase2 current 33rd harmonic	RO	%	32 bit flo t
258	L2 I Harmonics 35	Phase2 current 35th harmonic	RO	%	32 bit flo t
260	L2 I Harmonics 37	Phase2 current 37th harmonic	RO	%	32 bit flo t
262	L2 I Harmonics 39	Phase2 current 39th harmonic	RO	%	32 bit flo t
264	L2 I Harmonics 41	Phase2 current 41st harmonic	RO	%	32 bit flo t
266	L2 I Harmonics 43	Phase2 current 43rd harmonic	RO	%	32 bit flo t
268	L2 I Harmonics 45	Phase2 current 45th harmonic	RO	%	32 bit flo t
270	L2 I Harmonics 47	Phase2 current 47th harmonic	RO	%	32 bit flo t
272	L2 I Harmonics 49	Phase2 current 49th harmonic	RO	%	32 bit flo t
274	L2 I Harmonics 51	Phase2 current 51st harmonic	RO	%	32 bit flo t
PHASE 3					
276	L3 V	Phase3 voltage	RO	V	32 bit flo t
278	L3 I	Phase3 current	RO	A	32 bit flo t
280	L3 P	Phase3 active power	RO	W	32 bit flo t
282	L3 Q	Phase3 reactive power	RO	VAr	32 bit flo t
284	L3 S	Phase3 apparent power	RO	VA	32 bit flo t
286	L3 CosØ	Phase3 CosØ	RO	-	32 bit flo t
288	L3 PF	Phase3 power factor	RO	-	32 bit flo t
290	L3 F	Phase3 frequency	RO	Hz	32 bit flo t
292	L3 THDV	Phase3 total har. distortion of voltage	RO	%	32 bit flo t
294	L3 THDI	Phase3 total har. distortion of current	RO	%	32 bit flo t
296	L3 V Harmonics 1	Phase3 voltage first harmonic	RO	%	32 bit flo t
298	L3 V Harmonics 3	Phase3 voltage third harmonic	RO	%	32 bit flo t
300	L3 V Harmonics 5	Phase3 voltage 5th harmonic	RO	%	32 bit flo t
302	L3 V Harmonics 7	Phase3 voltage 7th harmonic	RO	%	32 bit flo t
304	L3 V Harmonics 9	Phase3 voltage 9th harmonic	RO	%	32 bit flo t
306	L3 V Harmonics 11	Phase3 voltage 11th harmonic	RO	%	32 bit flo t
308	L3 V Harmonics 13	Phase3 voltage 13th harmonic	RO	%	32 bit flo t
310	L3 V Harmonics 15	Phase3 voltage 15th harmonic	RO	%	32 bit flo t
312	L3 V Harmonics 17	Phase3 voltage 17th harmonic	RO	%	32 bit flo t
314	L3 V Harmonics 19	Phase3 voltage 19th harmonic	RO	%	32 bit flo t
316	L3 V Harmonics 21	Phase3 voltage 21st harmonic	RO	%	32 bit flo t
318	L3 V Harmonics 23	Phase3 voltage 23rd harmonic	RO	%	32 bit flo t
320	L3 V Harmonics 25	Phase3 voltage 25th harmonic	RO	%	32 bit flo t
322	L3 V Harmonics 27	Phase3 voltage 27th harmonic	RO	%	32 bit flo t
324	L3 V Harmonics 29	Phase3 voltage 29th harmonic	RO	%	32 bit flo t
326	L3 V Harmonics 31	Phase3 voltage 31st harmonic	RO	%	32 bit flo t
328	L3 V Harmonics 33	Phase3 voltage 33rd harmonic	RO	%	32 bit flo t
330	L3 V Harmonics 35	Phase3 voltage 35th harmonic	RO	%	32 bit flo t
332	L3 V Harmonics 37	Phase3 voltage 37th harmonic	RO	%	32 bit flo t
334	L3 V Harmonics 39	Phase3 voltage 39th harmonic	RO	%	32 bit flo t
336	L3 V Harmonics 41	Phase3 voltage 41st harmonic	RO	%	32 bit flo t
338	L3 V Harmonics 43	Phase3 voltage 43rd harmonic	RO	%	32 bit flo t

Address	Parameter	Description	R/W	Unit	Data Type
340	L3 V Harmonics 45	Phase3 voltage 45th harmonic	RO	%	32 bit flo t
342	L3 V Harmonics 47	Phase3 voltage 47th harmonic	RO	%	32 bit flo t
344	L3 V Harmonics 49	Phase3 voltage 49th harmonic	RO	%	32 bit flo t
346	L3 V Harmonics 51	Phase3 voltage 51st harmonic	RO	%	32 bit flo t
348	L3 I Harmonics 1	Phase3 current first harmonic	RO	%	32 bit flo t
350	L3 I Harmonics 3	Phase3 current third harmonic	RO	%	32 bit flo t
352	L3 I Harmonics 5	Phase3 current 5th harmonic	RO	%	32 bit flo t
354	L3 I Harmonics 7	Phase3 current 7th harmonic	RO	%	32 bit flo t
356	L3 I Harmonics 9	Phase3 current 9th harmonic	RO	%	32 bit flo t
358	L3 I Harmonics 11	Phase3 current 11th harmonic	RO	%	32 bit flo t
360	L3 I Harmonics 13	Phase3 current 13th harmonic	RO	%	32 bit flo t
362	L3 I Harmonics 15	Phase3 current 15th harmonic	RO	%	32 bit flo t
364	L3 I Harmonics 17	Phase3 current 17th harmonic	RO	%	32 bit flo t
366	L3 I Harmonics 19	Phase3 current 19th harmonic	RO	%	32 bit flo t
368	L3 I Harmonics 21	Phase3 current 21st harmonic	RO	%	32 bit flo t
370	L3 I Harmonics 23	Phase3 current 23rd harmonic	RO	%	32 bit flo t
372	L3 I Harmonics 25	Phase3 current 25th harmonic	RO	%	32 bit flo t
374	L3 I Harmonics 27	Phase3 current 27th harmonic	RO	%	32 bit flo t
376	L3 I Harmonics 29	Phase3 current 29th harmonic	RO	%	32 bit flo t
378	L3 I Harmonics 31	Phase3 current 31st harmonic	RO	%	32 bit flo t
380	L3 I Harmonics 33	Phase3 current 33rd harmonic	RO	%	32 bit flo t
382	L3 I Harmonics 35	Phase3 current 35th harmonic	RO	%	32 bit flo t
384	L3 I Harmonics 37	Phase3 current 37th harmonic	RO	%	32 bit flo t
386	L3 I Harmonics 39	Phase3 current 39th harmonic	RO	%	32 bit flo t
388	L3 I Harmonics 41	Phase3 current 41st harmonic	RO	%	32 bit flo t
390	L3 I Harmonics 43	Phase3 current 43rd harmonic	RO	%	32 bit flo t
392	L3 I Harmonics 45	Phase3 current 45th harmonic	RO	%	32 bit flo t
394	L3 I Harmonics 47	Phase3 current 47th harmonic	RO	%	32 bit flo t
396	L3 I Harmonics 49	Phase3 current 49th harmonic	RO	%	32 bit flo t
398	L3 I Harmonics 51	Phase3 current 51st harmonic	RO	%	32 bit flo t
ALARM FLAGS					
400	Alarms 1	Alarm flag 1 (first 32 bit	RO	-	32 bit int.
402	Alarms 2	Alarm flag 2 (se ond 32 bit)	RO	-	32 bit int.
STEP VARIABLES					
404	Active step	Active step flag	RO	-	32 bit int.
406	Available step	Available step flag	RO	-	32 bit int.
408	Fixed step	Fixed step flag	RO	-	32 bit int.
410	S1 switching count	Step 1 switching count	RO	-	32 bit int.
412	S2 switching count	Step 2 switching count	RO	-	32 bit int.
414	S3 switching count	Step 3 switching count	RO	-	32 bit int.
416	S4 switching count	Step 4 switching count	RO	-	32 bit int.
418	S5 switching count	Step 5 switching count	RO	-	32 bit int.
420	S6 switching count	Step 6 switching count	RO	-	32 bit int.
422	S7 switching count	Step 7 switching count	RO	-	32 bit int.

Address	Parameter	Description	R/W	Unit	Data Type
424	S8 switching count	Step 8 switching count	RO	-	32 bit int.
426	S9 switching count	Step 9 switching count	RO	-	32 bit int.
428	S10 switching count	Step 10 switching count	RO	-	32 bit int.
430	S11 switching count	Step 11 switching count	RO	-	32 bit int.
432	S12 switching count	Step 12 switching count	RO	-	32 bit int.
434	S13 switching count	Step 13 switching count	RO	-	32 bit int.
436	S14 switching count	Step 14 switching count	RO	-	32 bit int.
438	S15 switching count	Step 15 switching count	RO	-	32 bit int.
440	S16 switching count	Step 16 switching count	RO	-	32 bit int.
442	S17 switching count	Step 17 switching count	RO	-	32 bit int.
444	S18 switching count	Step 18 switching count	RO	-	32 bit int.
446	S19 switching count	Step 19 switching count	RO	-	32 bit int.
448	S20 switching count	Step 20 switching count	RO	-	32 bit int.
450	S21 switching count	Step 21 switching count	RO	-	32 bit int.
452	S22 switching count	Step 22 switching count	RO	-	32 bit int.
454	S23 switching count	Step 23 switching count	RO	-	32 bit int.
456	S24 switching count	Step 24 switching count	RO	-	32 bit int.
458	S1 operation time	Step 1 operation time	RO	min.	32 bit int.
460	S2 operation time	Step 2 operation time	RO	min.	32 bit int.
462	S3 operation time	Step 3 operation time	RO	min.	32 bit int.
464	S4 operation time	Step 4 operation time	RO	min.	32 bit int.
466	S5 operation time	Step 5 operation time	RO	min.	32 bit int.
468	S6 operation time	Step 6 operation time	RO	min.	32 bit int.
470	S7 operation time	Step 7 operation time	RO	min.	32 bit int.
472	S8 operation time	Step 8 operation time	RO	min.	32 bit int.
474	S9 operation time	Step 9 operation time	RO	min.	32 bit int.
476	S10 operation time	Step 10 operation time	RO	min.	32 bit int.
478	S11 operation time	Step 11 operation time	RO	min.	32 bit int.
480	S12 operation time	Step 12 operation time	RO	min.	32 bit int.
482	S13 operation time	Step 13 operation time	RO	min.	32 bit int.
484	S14 operation time	Step 14 operation time	RO	min.	32 bit int.
486	S15 operation time	Step 15 operation time	RO	min.	32 bit int.
488	S16 operation time	Step 16 operation time	RO	min.	32 bit int.
490	S17 operation time	Step 17 operation time	RO	min.	32 bit int.
492	S18 operation time	Step 18 operation time	RO	min.	32 bit int.
494	S19 operation time	Step 19 operation time	RO	min.	32 bit int.
496	S20 operation time	Step 20 operation time	RO	min.	32 bit int.
498	S21 operation time	Step 21 operation time	RO	min.	32 bit int.
500	S22 operation time	Step 22 operation time	RO	min.	32 bit int.
502	S23 operation time	Step 23 operation time	RO	min.	32 bit int.
504	S24 operation time	Step 24 operation time	RO	min.	32 bit int.
ENERGY METERS (32 bit)					
506	T1 Imp. Act. Index	Tariff 1 mport Active Index	RO	kWh	32 bit flo t
508	T1 Imp. Act. Curr. Hour	Tariff 1 mport Active Current Hour	RO	kWh	32 bit flo t

Address	Parameter	Description	R/W	Unit	Data Type
510	T1 Imp. Act. Prev. Hour	Tariff 1 mport Active Previous Hour	RO	kWh	32 bit flo t
512	T1 Imp. Act. Curr. Day	Tariff 1 mport. Active Current Day	RO	kWh	32 bit flo t
514	T1 Imp. Act. Prev. Day	Tariff 1 mport Active Previous Day	RO	kWh	32 bit flo t
516	T1 Imp. Act. Curr. Month	Tariff 1 mport Active Current Month	RO	kWh	32 bit flo t
518	T1 Imp. Act. Prev. Month	Tariff 1 mport Previous Month	RO	kWh	32 bit flo t
520	T1 Exp. Act. Index	Tariff 1 Expo t Active Index	RO	kWh	32 bit flo t
522	T1 Exp. Act. Curr. Hour	Tariff 1 Expo t Active Current Hour	RO	kWh	32 bit flo t
524	T1 Exp. Act. Prev. Hour	Tariff 1 Expo t Active Previous Hour	RO	kWh	32 bit flo t
526	T1 Exp. Act. Curr. Day	Tariff 1 Expo t Active Current Day	RO	kWh	32 bit flo t
528	T1 Exp. Act. Prev. Day	Tariff 1 Expo t Active Previous Day	RO	kWh	32 bit flo t
530	T1 Exp. Act. Curr. Month	Tariff 1 Expo t Active Current Month	RO	kWh	32 bit flo t
532	T1 Exp. Act. Prev. Month	Tariff 1 Expo t Active Previous Month	RO	kWh	32 bit flo t
534	T1 Ind. React. Index	Tariff 1 nductive Reactive Index	RO	kVArh	32 bit flo t
536	T1 Ind. React. Curr. Hour	Tariff 1 nductive Reactive Current Hour	RO	kVArh	32 bit flo t
538	T1 Ind. React. Prev. Hour	Tariff 1 nductive Reactive Previous Hour	RO	kVArh	32 bit flo t
540	T1 Ind. React. Curr. Day	Tariff 1 nductive Reactive Current Day	RO	kVArh	32 bit flo t
542	T1 Ind. React. Prev. Day	Tariff 1 nductive Reactive Previous Day	RO	kVArh	32 bit flo t
544	T1 Ind. React. Curr. Month	Tariff 1 nductive Reactive Current Month	RO	kVArh	32 bit flo t
546	T1 Ind. React. Prev. Month	Tariff 1 nductive Reactive Previous Month	RO	kVArh	32 bit flo t
548	T1 Cap. React. Index	Tariff 1 apacitive Reactive Index	RO	kVArh	32 bit flo t
550	T1 Cap. React. Curr. Hour	Tariff 1 apacitive Reactive Current Hour	RO	kVArh	32 bit flo t
552	T1 Cap. React. Prev. Hour	Tariff 1 apacitive Reactive Previous Hour	RO	kVArh	32 bit flo t
554	T1 Cap. React. Curr. Day	Tariff 1 apacitive Reactive Current Day	RO	kVArh	32 bit flo t
556	T1 Cap. React. Prev. Day	Tariff 1 apacitive Reactive Previous Day	RO	kVArh	32 bit flo t
558	T1 Cap. React. Curr. Month	Tariff 1 apacitive Reactive Current Month	RO	kVArh	32 bit flo t
560	T1 Cap. React. Prev. Month	Tariff 1 apacitive Reactive Previous Month	RO	kVArh	32 bit flo t
DEMAND					
562	Curr. Month P tot.	Current Month Total Active Power	RO	W	32 bit flo t
564	Curr. Month P tot. time	Current Month Total Active Power Timestamp	RO	-	32 bit unix time
566	Curr. Month I tot.	Current Month Total Current	RO	A	32 bit flo t
568	Curr. Month I tot. time	Current Month Total Current Timestamp	RO	-	32 bit unix time
570	Curr. Month Q tot.	Current Month Total Reactive Power	RO	VAr	32 bit flo t
572	Curr. Month Q tot. time	Current Month Total Reactive Power Timestamp	RO	-	32 bit unix time
574	Curr. Month S tot.	Current Month Total Apparent Power	RO	VA	32 bit flo t
576	Curr. Month S tot. time	Current Month Total Apparent Power Timestamp	RO	-	32 bit unix time
578	Curr. Month L1 P	Current Month Phase 1 Active Power	RO	W	32 bit flo t
580	Curr. Month L1 P time	Current Month Phase 1 Active Power Timestamp	RO	-	32 bit unix time
582	Curr. Month L1 I	Current Month Phase 1 Current	RO	A	32 bit flo t
584	Curr. Month L1 I time	Current Month Phase 1 Current Timestamp	RO	-	32 bit unix time
586	Curr. Month L1 Q	Current Month Phase 1 Reactive Power	RO	VAr	32 bit flo t
588	Curr. Month L1 Q time	Current Month Phase 1 Reactive Power Timestamp	RO	-	32 bit unix time

Address	Parameter	Description	R/W	Unit	Data Type
590	Curr. Month L1 S	Current Month Phase 1 Apparent Power	RO	VA	32 bit flo t
592	Curr. Month L1 S time	Current Month Phase 1 Apparent Power Timestamp	RO	-	32 bit unix time
594	Curr. Month L2 P	Current Month Phase 2 Active Power	RO	W	32 bit flo t
596	Curr. Month L2 P time	Current Month Phase 2 Active Power Timestamp	RO	-	32 bit unix time
598	Curr. Month L2 I	Current Month Phase 2 Current	RO	A	32 bit flo t
600	Curr. Month L2 I time	Current Month Phase 2 Current Timestamp	RO	-	32 bit unix time
602	Curr. Month L2 Q	Current Month Phase 2 Reactive Power	RO	VAr	32 bit flo t
604	Curr. Month L2 Q time	Current Month Phase 2 Reactive Power Timestamp	RO	-	32 bit unix time
606	Curr. Month L2 S	Current Month Phase 2 Apparent Power	RO	VA	32 bit flo t
608	Curr. Month L2 S time	Current Month Phase 2 Apparent Power Timestamp	RO	-	32 bit unix time
610	Curr. Month L3 P	Current Month Phase 3 Active Power	RO	W	32 bit flo t
612	Curr. Month L3 P time	Current Month Phase 3 Active Power Timestamp	RO	-	32 bit unix time
614	Curr. Month L3 I	Current Month Phase 3 Current	RO	A	32 bit flo t
616	Curr. Month L3 I time	Current Month Phase 3 Current Timestamp	RO	-	32 bit unix time
618	Curr. Month L3 Q	Current Month Phase 3 Reactive Power	RO	VAr	32 bit flo t
620	Curr. Month L3 Q time	Current Month Phase 3 Reactive Power Timestamp	RO	-	32 bit unix time
622	Curr. Month L3 S	Current Month Phase 3 Apparent Power	RO	VA	32 bit flo t
624	Curr. Month L3 S time	Current Month Phase 3 Apparent Power Timestamp	RO	-	32 bit unix time
OTHER					
626	Temp.	Temperature Value	RO	°C	32 bit flo t
628	Battery Voltage	-	RO	V	32 bit flo t
630	Time	System Date and Time	R/W	-	32 bit unix time
ALARM STATUSES					
632	1 - Alarm Timestamp	1 - Alarm time	RO	-	32 bit unix time
634	1 - Alarm ID	1 - Alarm ID	RO	-	32 bit int.
636	1 - Alarm Status	1 - Alarm ON /Alarm OFF status	RO	-	32 bit int.
638	1 - Alarm Value	1 - Value of related alarm parameter	RO	-	32 bit flo t
640	2 - Alarm Timestamp	2 - Alarm time	RO	-	32 bit unix time
642	2 - Alarm ID	2 - Alarm ID	RO	-	32 bit int.
644	2 - Alarm Status	2 - Alarm ON /Alarm OFF status	RO	-	32 bit int.
646	2 - Alarm Value	2 - Value of related alarm parameter	RO	-	32 bit flo t
648	3 - Alarm Timestamp	3 - Alarm time	RO	-	32 bit unix time
650	3 - Alarm ID	3 - Alarm ID	RO	-	32 bit int.
652	3 - Alarm Status	3 - Alarm ON /Alarm OFF status	RO	-	32 bit int.
654	3 - Alarm Value	3 - Value of related alarm parameter	RO	-	32 bit flo t
656	4 - Alarm Timestamp	4 - Alarm time	RO	-	32 bit unix time
658	4 - Alarm ID	4 - Alarm ID	RO	-	32 bit int.
660	4 - Alarm Status	4 - Alarm ON /Alarm OFF status	RO	-	32 bit int.
662	4 - Alarm Value	4 - Value of related alarm parameter	RO	-	32 bit flo t

Address	Parameter	Description	R/W	Unit	Data Type
664	5 - Alarm Timestamp	5 - Alarm time	RO	-	32 bit unix time
666	5 - Alarm ID	5 - Alarm ID	RO	-	32 bit int.
668	5 - Alarm Status	5 - Alarm ON /Alarm OFF status	RO	-	32 bit int.
670	5 - Alarm Value	5 - Value of related alarm parameter	RO	-	32 bit flo t
672	6 - Alarm Timestamp	6 - Alarm time	RO	-	32 bit unix time
674	6 - Alarm ID	6 - Alarm ID	RO	-	32 bit int.
676	6 - Alarm Status	6 - Alarm ON /Alarm OFF status	RO	-	32 bit int.
678	6 - Alarm Value	6 - Value of related alarm parameter	RO	-	32 bit flo t
680	7 - Alarm Timestamp	7 - Alarm time	RO	-	32 bit unix time
682	7 - Alarm ID	7 - Alarm ID	RO	-	32 bit int.
684	7 - Alarm Status	7 - Alarm ON /Alarm OFF status	RO	-	32 bit int.
686	7 - Alarm Value	7 - Value of related alarm parameter	RO	-	32 bit flo t
688	8 - Alarm Timestamp	8 - Alarm time	RO	-	32 bit unix time
690	8 - Alarm ID	8 - Alarm ID	RO	-	32 bit int.
692	8 - Alarm Status	8 - Alarm ON /Alarm OFF status	RO	-	32 bit int.
694	8 - Alarm Value	8 - Value of related alarm parameter	RO	-	32 bit flo t
696	9 - Alarm Timestamp	9 - Alarm time	RO	-	32 bit unix time
698	9 - Alarm ID	9 - Alarm ID	RO	-	32 bit int.
700	9 - Alarm Status	9 - Alarm ON /Alarm OFF status	RO	-	32 bit int.
702	9 - Alarm Value	9 - Value of related alarm parameter	RO	-	32 bit flo t
704	10 - Alarm Timestamp	10 - Alarm time	RO	-	32 bit unix time
706	10 - Alarm ID	10 - Alarm ID	RO	-	32 bit int.
708	10 - Alarm Status	10 - Alarm ON /Alarm OFF status	RO	-	32 bit int.
710	10 - Alarm Value	10 - Value of related alarm parameter	RO	-	32 bit flo t
712	11 - Alarm Timestamp	11 - Alarm time	RO	-	32 bit unix time
714	11 - Alarm ID	11 - Alarm ID	RO	-	32 bit int.
716	11 - Alarm Status	11 - Alarm ON /Alarm OFF status	RO	-	32 bit int.
718	11 - Alarm Value	11 - Value of related alarm parameter	RO	-	32 bit flo t
720	12 - Alarm Timestamp	12 - Alarm time	RO	-	32 bit unix time
722	12 - Alarm ID	12 - Alarm ID	RO	-	32 bit int.
724	12 - Alarm Status	12 - Alarm ON /Alarm OFF status	RO	-	32 bit int.
726	12 - Alarm Value	12 - Value of related alarm parameter	RO	-	32 bit flo t
728	13 - Alarm Timestamp	13 - Alarm time	RO	-	32 bit unix time
730	13 - Alarm ID	13 - Alarm ID	RO	-	32 bit int.
732	13 - Alarm Status	13 - Alarm ON /Alarm OFF status	RO	-	32 bit int.
734	13 - Alarm Value	13 - Value of related alarm parameter	RO	-	32 bit flo t
736	14 - Alarm Timestamp	14 - Alarm time	RO	-	32 bit unix time
738	14 - Alarm ID	14 - Alarm ID	RO	-	32 bit int.
740	14 - Alarm Status	14 - Alarm ON /Alarm OFF status	RO	-	32 bit int.
742	14 - Alarm Value	14 - Value of related alarm parameter	RO	-	32 bit flo t
744	15 - Alarm Timestamp	15 - Alarm zaman değeri	RO	-	32 bit unix time
746	15 - Alarm ID	15 - Alarm ID	RO	-	32 bit int.
748	15 - Alarm Status	15 - Alarm ON /Alarm OFF status	RO	-	32 bit int.
750	15 - Alarm Value	15 - Value of related alarm parameter	RO	-	32 bit flo t

Address	Parameter	Description	R/W	Unit	Data Type
752	16 - Alarm Timestamp	16 - Alarm time	RO	-	32 bit unix time
754	16 - Alarm ID	16 - Alarm ID	RO	-	32 bit int.
756	16 - Alarm Status	16 - Alarm ON /Alarm OFF status	RO	-	32 bit int.
758	16 - Alarm Value	16 - Value of related alarm parameter	RO	-	32 bit flo t
760	17 - Alarm Timestamp	17 - Alarm time	RO	-	32 bit unix time
762	17 - Alarm ID	17 - Alarm ID	RO	-	32 bit int.
764	17 - Alarm Status	17 - Alarm ON /Alarm OFF status	RO	-	32 bit int.
766	17 - Alarm Value	17 - Value of related alarm parameter	RO	-	32 bit flo t
768	18 - Alarm Timestamp	18 - Alarm time	RO	-	32 bit unix time
770	18 - Alarm ID	18 - Alarm ID	RO	-	32 bit int.
772	18 - Alarm Status	18 - Alarm ON /Alarm OFF status	RO	-	32 bit int.
774	18 - Alarm Value	18 - Value of related alarm parameter	RO	-	32 bit flo t
776	19- Alarm Timestamp	19 - Alarm time	RO	-	32 bit unix time
778	19 - Alarm ID	19 - Alarm ID	RO	-	32 bit int.
780	19- Alarm Status	19 - Alarm ON /Alarm OFF status	RO	-	32 bit int.
782	19 - Alarm Value	19- Value of related alarm parameter	RO	-	32 bit flo t
784	20 - Alarm Timestamp	20 - Alarm time	RO	-	32 bit unix time
786	20 - Alarm ID	20 - Alarm ID	RO	-	32 bit int.
788	20 - Alarm Status	20 - Alarm ON /Alarm OFF status	RO	-	32 bit int.
790	20 - Alarm Value	20 - Value of related alarm parameter	RO	-	32 bit flo t
792	21 - Alarm Timestamp	21 - Alarm time	RO	-	32 bit unix time
794	21 - Alarm ID	21 - Alarm ID	RO	-	32 bit int.
796	21 - Alarm Status	21 - Alarm ON /Alarm OFF status	RO	-	32 bit int.
798	21 - Alarm Value	21 - Value of related alarm parameter	RO	-	32 bit flo t
800	22 - Alarm Timestamp	22 - Alarm time	RO	-	32 bit unix time
802	22 - Alarm ID	22 - Alarm ID	RO	-	32 bit int.
804	22 - Alarm Status	22 - Alarm ON /Alarm OFF status	RO	-	32 bit int.
806	22 - Alarm Value	22 - Value of related alarm parameter	RO	-	32 bit flo t
808	23 - Alarm Timestamp	23 - Alarm time	RO	-	32 bit unix time
810	23 - Alarm ID	23 - Alarm ID	RO	-	32 bit int.
812	23 - Alarm Status	23 - Alarm ON /Alarm OFF status	RO	-	32 bit int.
814	23 - Alarm Value	23 - Value of related alarm parameter	RO	-	32 bit flo t
816	24 - Alarm Timestamp	24 - Alarm time	RO	-	32 bit unix time
818	24 - Alarm ID	24 - Alarm ID	RO	-	32 bit int.
820	24 - Alarm Status	24 - Alarm ON /Alarm OFF status	RO	-	32 bit int.
822	24 - Alarm Value	24 - Value of related alarm parameter	RO	-	32 bit flo t
824	25 - Alarm Timestamp	25 - Alarm time	RO	-	32 bit unix time
826	25 - Alarm ID	25 - Alarm ID	RO	-	32 bit int.
828	25 - Alarm Status	25 - Alarm ON /Alarm OFF status	RO	-	32 bit int.
830	25 - Alarm Value	25 - Value of related alarm parameter	RO	-	32 bit flo t
832	26 - Alarm Timestamp	26 - Alarm time	RO	-	32 bit unix time
834	26 - Alarm ID	26 - Alarm ID	RO	-	32 bit int.
836	26 - Alarm Status	26 - Alarm ON /Alarm OFF status	RO	-	32 bit int.
838	26 - Alarm Value	26 - Value of related alarm parameter	RO	-	32 bit flo t

Address	Parameter	Description	R/W	Unit	Data Type
840	27 - Alarm Timestamp	27 - Alarm time	RO	-	32 bit unix time
842	27 - Alarm ID	27 - Alarm ID	RO	-	32 bit int.
844	27 - Alarm Status	27 - Alarm ON /Alarm OFF status	RO	-	32 bit int.
846	27 - Alarm Value	27 - Value of related alarm parameter	RO	-	32 bit flo t
848	28 - Alarm Timestamp	28 - Alarm time	RO	-	32 bit unix time
850	28 - Alarm ID	28 - Alarm ID	RO	-	32 bit int.
852	28 - Alarm Status	28 - Alarm ON /Alarm OFF status	RO	-	32 bit int.
854	28 - Alarm Value	28 - Value of related alarm parameter	RO	-	32 bit flo t
856	29 - Alarm Timestamp	29 - Alarm time	RO	-	32 bit unix time
858	29 - Alarm ID	29 - Alarm ID	RO	-	32 bit int.
860	29 - Alarm Status	29 - Alarm ON /Alarm OFF status	RO	-	32 bit int.
862	29 - Alarm Value	29 - Value of related alarm parameter	RO	-	32 bit flo t
864	30 - Alarm Timestamp	30 - Alarm time	RO	-	32 bit unix time
866	30 - Alarm ID	30 - Alarm ID	RO	-	32 bit int.
868	30 - Alarm Status	30 - Alarm ON /Alarm OFF status	RO	-	32 bit int.
870	30 - Alarm Value	30 - Value of related alarm parameter	RO	-	32 bit flo t
872	31 - Alarm Timestamp	31 - Alarm time	RO	-	32 bit unix time
874	31 - Alarm ID	31 - Alarm ID	RO	-	32 bit int.
876	31 - Alarm Status	31 - Alarm ON /Alarm OFF status	RO	-	32 bit int.
878	31 - Alarm Value	31 - Value of related alarm parameter	RO	-	32 bit flo t
880	31 - Alarm Timestamp	32 - Alarm time	RO	-	32 bit unix time
882	32 - Alarm ID	32 - Alarm ID	RO	-	32 bit int.
884	32 - Alarm Status	32 - Alarm ON /Alarm OFF status	RO	-	32 bit int.
886	32 - Alarm Value	32 - Value of related alarm parameter	RO	-	32 bit flo t
888	33 - Alarm Timestamp	33 - Alarm time	RO	-	32 bit unix time
890	33 - Alarm ID	33 - Alarm ID	RO	-	32 bit int.
892	33 - Alarm Status	33 - Alarm ON /Alarm OFF status	RO	-	32 bit int.
894	33 - Alarm Value	33 - Value of related alarm parameter	RO	-	32 bit flo t
896	34 - Alarm Timestamp	34 - Alarm time	RO	-	32 bit unix time
898	34 - Alarm ID	34 - Alarm ID	RO	-	32 bit int.
900	34 - Alarm Status	34 - Alarm ON /Alarm OFF status	RO	-	32 bit int.
902	34 - Alarm Value	34 - Value of related alarm parameter	RO	-	32 bit flo t
904	35 - Alarm Timestamp	35 - Alarm time	RO	-	32 bit unix time
906	35 - Alarm ID	35 - Alarm ID	RO	-	32 bit int.
908	35 - Alarm Status	35 - Alarm ON /Alarm OFF status	RO	-	32 bit int.
910	35 - Alarm Value	35 - Value of related alarm parameter	RO	-	32 bit flo t
912	36 - Alarm Timestamp	36 - Alarm time	RO	-	32 bit unix time
914	36 - Alarm ID	36 - Alarm ID	RO	-	32 bit int.
916	36 - Alarm Status	36 - Alarm ON /Alarm OFF status	RO	-	32 bit int.
918	36 - Alarm Value	36 - Value of related alarm parameter	RO	-	32 bit flo t
920	37 - Alarm Timestamp	37 - Alarm time	RO	-	32 bit unix time
922	37 - Alarm ID	37 - Alarm ID	RO	-	32 bit int.
924	37 - Alarm Status	37 - Alarm ON /Alarm OFF status	RO	-	32 bit int.
926	37 - Alarm Value	37 - Value of related alarm parameter	RO	-	32 bit flo t

Address	Parameter	Description	R/W	Unit	Data Type
928	38 - Alarm Timestamp	38 - Alarm time	RO	-	32 bit unix time
930	38 - Alarm ID	38 - Alarm ID	RO	-	32 bit int.
932	38 - Alarm Status	38 - Alarm ON /Alarm OFF status	RO	-	32 bit int.
934	38 - Alarm Value	38 - Value of related alarm parameter	RO	-	32 bit flo t
936	39 - Alarm Timestamp	39 - Alarm time	RO	-	32 bit unix time
938	39 - Alarm ID	39 - Alarm ID	RO	-	32 bit int.
940	39 - Alarm Status	39 - Alarm ON /Alarm OFF status	RO	-	32 bit int.
942	39 - Alarm Value	39 - Value of related alarm parameter	RO	-	32 bit flo t
944	40 - Alarm Timestamp	40 - Alarm time	RO	-	32 bit unix time
946	40 - Alarm ID	40 - Alarm ID	RO	-	32 bit int.
948	40 - Alarm Status	40 - Alarm ON /Alarm OFF status	RO	-	32 bit int.
950	40 - Alarm Value	40 - Value of related alarm parameter	RO	-	32 bit flo t
952	41 - Alarm Timestamp	41 - Alarm time	RO	-	32 bit unix time
954	41 - Alarm ID	41 - Alarm ID	RO	-	32 bit int.
956	41 - Alarm Status	41 - Alarm ON /Alarm OFF status	RO	-	32 bit int.
958	41 - Alarm Value	41 - Value of related alarm parameter	RO	-	32 bit flo t
960	42 - Alarm Timestamp	42 - Alarm time	RO	-	32 bit unix time
962	42 - Alarm ID	42 - Alarm ID	RO	-	32 bit int.
964	42 - Alarm Status	42 - Alarm ON /Alarm OFF status	RO	-	32 bit int.
966	42 - Alarm Value	42 - Value of related alarm parameter	RO	-	32 bit flo t
968	43 - Alarm Timestamp	43 - Alarm time	RO	-	32 bit unix time
970	43 - Alarm ID	43 - Alarm ID	RO	-	32 bit int.
972	43 - Alarm Status	43 - Alarm ON /Alarm OFF status	RO	-	32 bit int.
974	43 - Alarm Value	43 - Value of related alarm parameter	RO	-	32 bit flo t
976	44 - Alarm Timestamp	44 - Alarm time	RO	-	32 bit unix time
978	44 - Alarm ID	44 - Alarm ID	RO	-	32 bit int.
980	44 - Alarm Status	44 - Alarm ON /Alarm OFF status	RO	-	32 bit int.
982	44 - Alarm Value	44 - Value of related alarm parameter	RO	-	32 bit flo t
984	45 - Alarm Timestamp	45 - Alarm time	RO	-	32 bit unix time
986	45 - Alarm ID	45 - Alarm ID	RO	-	32 bit int.
988	45 - Alarm Status	45 - Alarm ON /Alarm OFF status	RO	-	32 bit int.
990	45 - Alarm Value	45 - Value of related alarm parameter	RO	-	32 bit flo t
992	46 - Alarm Timestamp	46 - Alarm time	RO	-	32 bit unix time
994	46 - Alarm ID	46 - Alarm ID	RO	-	32 bit int.
996	46 - Alarm Status	46 - Alarm ON /Alarm OFF status	RO	-	32 bit int.
998	46 - Alarm Value	46 - Value of related alarm parameter	RO	-	32 bit flo t
1000	47 - Alarm Timestamp	47 - Alarm time	RO	-	32 bit unix time
1002	47 - Alarm ID	47 - Alarm ID	RO	-	32 bit int.
1004	47 - Alarm Status	47 - Alarm ON /Alarm OFF status	RO	-	32 bit int.
1006	47 - Alarm Value	47 - Value of related alarm parameter	RO	-	32 bit flo t
1008	48 - Alarm Timestamp	48 - Alarm time	RO	-	32 bit unix time
1010	48 - Alarm ID	48 - Alarm ID	RO	-	32 bit int.
1012	48 - Alarm Status	48 - Alarm ON /Alarm OFF status	RO	-	32 bit int.
1014	48 - Alarm Value	48 - Value of related alarm parameter	RO	-	32 bit flo t

Address	Parameter	Description	R/W	Unit	Data Type
1016	49 - Alarm Timestamp	49 - Alarm time	RO	-	32 bit unix time
1018	49 - Alarm ID	49 - Alarm ID	RO	-	32 bit int.
1020	49 - Alarm Status	49 - Alarm ON /Alarm OFF status	RO	-	32 bit int.
1022	49 - Alarm Value	49 - Value of related alarm parameter	RO	-	32 bit flo t
1024	50 - Alarm Timestamp	50 - Alarm time	RO	-	32 bit unix time
1026	50 - Alarm ID	50 - Alarm ID	RO	-	32 bit int.
1028	50 - Alarm Status	50 - Alarm ON /Alarm OFF status	RO	-	32 bit int.
1030	50 - Alarm Value	50 - Value of related alarm parameter	RO	-	32 bit flo t
LAST SAVED FILE NUMBERS					
1032	Hourly Archival File Nr.	Latest recorded hourly archival file number	RO	-	32 bit int.
1034	Daily Archival File Nr.	Latest recorded daily archival file number	RO	-	32 bit int.
1036	Monthly Archival File Nr.	Latest recorded monthly archival file number	RO	-	32 bit int.
GENERATOR INPUT STATUS					
1038	GEN INPUT	Jenerator Active/Passive Status	RO	-	32 bit int.
ENERGY METERS (64 bit)					
1040	T1 Imp. Active Index	Tariff 1 mport Active Index	RO	kWh	64 bit double
1044	T1 Exp. Active Index	Tariff 1 Expo tActive Index	RO	kWh	64 bit double
1048	T1 Ind. Reactive Index	Tariff 1 nductive Reactive Index	RO	kVArh	64 bit double
1052	T1 Cap. Reactive Index	Tariff 1 apacitive Reactive Index	RO	kVArh	64 bit double

Unix time: Unix time is the number of seconds elapsed since midnight (00:00) Coordinated Universal Time (UTC) of January 1, 1970, not counting leaps seconds.

NOTE: Tariff Meters' Index Values can be read in 32 bit and/or 64bit flo ting point format. Mathematically, 64bit flo ting point representation is more accurate than 32 bit flo ting point format.

e.g.

When it is required to read "Tariff 1 mport Active Index" value, it can be received either 32 bit flo ting point format (modbus adr. 506) or in 64 bit flo ting point format (modbus adr. 1040).

If related index value is wanted to read more sensitive, 64bit versions must be selected.



4.5.1.2.1 Alarm Flags(RAPIDUS 232R-E)

Each bit of an alarm flag variable corresponds to 'one' alarm flag.

If any bit's value is "1", then there is alarm for that bit. On the contrary, a bit value of "1" means that there is NO alarm for that bit.

The contents of alarm flag variables are listed below.

Alarms 1

<u>b7</u> THDV1	<u>b6</u> I3	<u>b5</u> I2	<u>b4</u> I1	<u>b3</u> V3	<u>b2</u> V2	<u>b1</u> V1	<u>b0</u> Sic.
<u>b15</u> VLL31	<u>b14</u> VLL23	<u>b13</u> VLL12	<u>b12</u> V3 Harmonics	<u>b11</u> V2 Harmonics	<u>b10</u> V1 Harmonics	<u>b9</u> THDV3	<u>b8</u> THDV2
<u>b23</u> S1	<u>b22</u> Q3	<u>b21</u> Q2	<u>b20</u> Q1	<u>b19</u> P3	<u>b18</u> P2	<u>b17</u> P1	<u>b16</u> IN
<u>b31</u> PF3	<u>b30</u> PF2	<u>b29</u> PF1	<u>b28</u> COSØ3	<u>b27</u> COSØ2	<u>b26</u> COSØ1	<u>b25</u> S3	<u>b24</u> S2

Alarms 2

<u>b7</u> I2	<u>b6</u> I1	<u>b5</u> THDV3	<u>b4</u> THDV2	<u>b3</u> THDV1	<u>b2</u> F3	<u>b1</u> F2	<u>b0</u> F1
Harmonics		Harmonics					
<u>b15</u> -	<u>b14</u> -	<u>b13</u> Under Comp.	<u>b12</u> Over Comp.	<u>b11</u> Cap. Energy	<u>b10</u> Ind. Energy	<u>b9</u> Battery	<u>b8</u> I3 Harmonics
<u>b23</u> -	<u>b22</u> -	<u>b21</u> -	<u>b20</u> -	<u>b19</u> -	<u>b18</u> -	<u>b17</u> -	<u>b16</u> -
<u>b31</u> -	<u>b30</u> -	<u>b29</u> -	<u>b28</u> -	<u>b27</u> -	<u>b26</u> -	<u>b25</u> -	<u>b24</u> -



Abbreviations used for the Alarm Flags are:

Temp. : Temperature	S1 : Phase1 Apparent Power
V1 : Phase1 (L-N) Voltage	S2 : Phase2 Apparent Power
V2 : Phase2 (L-N) Voltage	S3 : Phase3 Apparent Power
V3 : Phase3 (L-N) Voltage	CosØ1 : Phase1 CosØ
I1 : Phase1 Current	CosØ2 : Phase2 CosØ
I2 : Phase2 Current	CosØ3 : Phase3 CosØ
I3 : Phase3 Current	PF1 : Phase1 Power Factor
THDV1 : Phase1 Total Harmonic Distortion in Voltage	PF2 : Phase2 Power Factor
THDV2 : Phase2 Total Harmonic Distortion in Voltage	PF3 : Phase3 Power Factor
THDV3 : Phase3 Total Harmonic Distortion in Voltage	F1 : Phase1 Frequency
V1 Harmonics : Phase1 Voltage Harmonics	F2 : Phase2 Frequency
V2 Harmonics : Phase2 Voltage Harmonics	F3 : Phase3 Frequency
V3 Harmonics : Phase3 Voltage Harmonics	THDI1 : Phase1 Total Harmonic Distortion in Current
VLL1 : Phase1-Phase2 Voltage	THDI2 : Phase2 Total Harmonic Distortion in Current
VLL2 : Phase2-Phase3 Voltage	THDI3 : Phase3 Total Harmonic Distortion in Current
VLL3 : Phase3-Phase1 Voltage	I1 Harmonics : Phase1 Current Harmonics
IN : Neutral Current	I2 Harmonics : Phase2 Current Harmonics
P1 : Phase1 Active Power	I3 Harmonics : Phase3 Current Harmonics
P2 : Phase2 Active Power	Battery : Battery Voltage
P3 : Phase3 Active Power	Ind. Energy : Inductive Energy
Q1 : Phase1 Reactive Power	Cap. Energy : Capacitive Energy
Q2 : Phase2 Reactive Power	Over Comp. : Over Compensation
Q3 : Phase3 Reactive Power	Under Comp. : Under Compensation

4.5.2 RAPIDUS Setting Parameters

Operator/programmer should use '10H - Write Multiple Registers and '06H - Write Single Register' to change settings parameters.

Operator/programmer should use '0x3H - Read Holding Registers' function to read setting parameters.

1 register -> comprises of 2 bytes.



After Rapidus setting parameters have been changed, in order for the new values to be saved in non-volatile memory; 0x0000 should be written to register 1998, and 0x0001 should be written in register 1999, within 60 seconds following the last setting change. Only after that, changes will be stored in the permanent memory.

NOTE1:

3 parameters given with "RO (Read Only)" in [Table 4-6](#) and [Table 4-8](#) are read-only data. They cannot be changed by the user. This data is as given below:

- Serial Number
- Firmware Version
- Compiler Version

NOTE2:

1998 addressed variable at the end of [Table 4-6](#) and [Table 4-8](#) are a "W (only writable)" variable.

4.5.2.1 Setting for RAPIDUS 231R-E

Table 4-6 Setting Parameter (Available for RAPIDUS 231R-E)

Address	Parameter	Data Type	Descript.	R/W	Unit	Low Limit	High Limit
NETWORK SETTINGS							
2000	Current Transf. Ratio (CTR)	32 bit flo t	-	R/W	-	1	5000
2002	Voltage Transf. Ratio (VTR)	32 bit flo t	-	R/W	-	1	5000
2004	Demand Period	32 bit int.	-	R/W	min.	1	60
ENERGY SETTINGS							
2006	Start of day	32 bit int.	-	R/W	hour	0	23
2008	Start of month	32 bit int.	-	R/W	-	1	28
2010	T1 kWh	32 bit flo t	-	R/W	kWh	0	20000000000.0
2012	T1 kWh E.	32 bit flo t	-	R/W	kWh	0	20000000000.0
2014	T1 kVArh I.	32 bit flo t	-	R/W	kVArh	0	20000000000.0
2016	T1 kVArh C.	32 bit flo t	-	R/W	kVArh	0	20000000000.0
STEP SETTINGS							
2018	Step1 power	32 bit flo t	-	R/W	kVArh	0	1000
2020	Step1 type	32 bit int.	S1	R/W	-	0	7
2022	Step2 power	32 bit flo t	-	R/W	kVArh	0	1000
2024	Step2 type	32 bit int.	S1	R/W	-	0	7
2026	Step3 power	32 bit flo t	-	R/W	kVArh	0	1000
2028	Step3 type	32 bit int.	S1	R/W	-	0	7
2030	Step4 power	32 bit flo t	-	R/W	kVArh	0	1000
2032	Step4 type	32 bit int.	S1	R/W	-	0	7
2034	Step5 power	32 bit flo t	-	R/W	kVArh	0	1000
2036	Step5 type	32 bit int.	S1	R/W	-	0	7
2038	Step6 power	32 bit flo t	-	R/W	kVArh	0	1000
2040	Step6 type	32 bit int.	S1	R/W	-	0	7
2042	Step7 power	32 bit flo t	-	R/W	kVArh	0	1000
2044	Step7 type	32 bit int.	S1	R/W	-	0	7
2046	Step8 power	32 bit flo t	-	R/W	kVArh	0	1000
2048	Step8 type	32 bit int.	S1	R/W	-	0	7
2050	Step9 power	32 bit flo t	-	R/W	kVArh	0	1000
2052	Step9 type	32 bit int.	S1	R/W	-	0	7

Address	Parameter	Data Type	Descript.	R/W	Unit	Low Limit	High Limit
2054	Step10 power	32 bit flo t	-	R/W	kVArh	0	1000
2056	Step10 type	32 bit int.	S1	R/W	-	0	7
2058	Step11 power	32 bit flo t	-	R/W	kVArh	0	1000
2060	Step11 type	32 bit int.	S1	R/W	-	0	7
2062	Step12 power	32 bit flo t	-	R/W	kVArh	0	1000
2064	Step12 type	32 bit int.	S1	R/W	-	0	7
2066	Bank structure	32 bit int.	S2	R/W	-	0	8
2068	Bank power	32 bit flo t	-	R/W	kVArh	0	1000
2070	Bank count	32 bit int.	-	R/W	-	0	12
2072	Discharge time	32 bit int.	-	R/W	sec	3	1000
COMPENSATION SETTINGS							
2074	Steps	32 bit int.	S3	R/W	-	0	2
2076	Program	32 bit int.	S4	R/W	-	0	4
2078	Target 1	32 bit flo t	-	R/W	-	-0.800	0.800
2080	Target 2	32 bit flo t	-	R/W	-	0.000	1.000
2082	Target low limit	32 bit flo t	-	R/W	-	0.000	0.200
2084	Target high limit	32 bit flo t	-	R/W	-	0.000	0.200
2086	Activation time	32 bit int.	-	R/W	sec	1	600
2088	Deactivation time	32 bit int.	-	R/W	sec	1	600
2090	Shift angle	32 bit flo t	-	R/W	-	-45	45
2092	Fixed steps	32 bit int.	S10	R/W	-	0	3
2094	Averaging time	32 bit int.	S14	R/W	-	0	7
COMMUNICATION SETTINGS							
2096	BaudRate	32 bit int.	S6	R/W	-	0	6
2098	Slaveld	32 bit int.	-	R/W	-	1	247
ALARM SETTINGS							
VOLTAGE (L-N) ALARM							
2100	Alarm relay	32 bit int.	S5	R/W	-	0	2
2102	Low limit	32 bit flo t	-	R/W	V	0	1500000
2104	High limit	32 bit flo t	-	R/W	V	0	1500000
2106	Alarm time	32 bit int.	-	R/W	sec	0	600
2108	Hysteresis	32 bit flo t	-	R/W	%	0	20
VOLTAGE (L-L) ALARM							
2110	Alarm relay	32 bit int.	S5	R/W	-	0	2
2112	Low limit	32 bit flo t	-	R/W	V	0	2600000
2114	High limit	32 bit flo t	-	R/W	V	0	2600000
2116	Alarm time	32 bit int.	-	R/W	sec	0	600
2118	Hysteresis	32 bit flo t	-	R/W	%	0	20
CURRENT ALARM							
2120	Alarm relay	32 bit int.	S5	R/W	-	0	2
2122	Low limit	32 bit flo t	-	R/W	A	0	30000
2124	High limit	32 bit flo t	-	R/W	A	0	30000
2126	Alarm time	32 bit int.	-	R/W	sec	0	600
2128	Hysteresis	32 bit flo t	-	R/W	%	0	20

Address	Parameter	Data Type	Descript.	R/W	Unit	Low Limit	High Limit
ACTIVE POWER ALARM							
2130	Alarm relay	32 bit int.	S5	R/W	-	0	2
2132	Low limit	32 bit flo t	-	R/W	W	-1,00E+10	1,00E+10
2134	High limit	32 bit flo t	-	R/W	W	-1,00E+10	1,00E+10
2136	Alarm time	32 bit int.	-	R/W	sec	0	600
2138	Hysteresis	32 bit flo t	-	R/W	%	0	20
REACTIVE POWER ALARM							
2140	Alarm relay	32 bit int.	S5	R/W	-	0	2
2142	Low limit	32 bit flo t	-	R/W	VAr	-1,00E+10	1,00E+10
2144	High limit	32 bit flo t	-	R/W	VAr	-1,00E+10	1,00E+10
2146	Alarm time	32 bit int.	-	R/W	sec	0	600
2148	Hysteresis	32 bit flo t	-	R/W	%	0	20
APPARENT POWER ALARM							
2150	Alarm relay	32 bit int.	S5	R/W	-	0	2
2152	Low limit	32 bit flo t	-	R/W	A	0	30000
2154	High limit	32 bit flo t	-	R/W	A	0	30000
2156	Alarm time	32 bit int.	-	R/W	sec	0	600
2158	Hysteresis	32 bit flo t	-	R/W	%	0	20
NEUTRAL CURRENT ALARM							
2160	Alarm relay	32 bit int.	S5	R/W	-	0	2
2162	Low limit	32 bit flo t	-	R/W	-	0	1
2164	High limit	32 bit flo t	-	R/W	-	0	1
2166	Alarm time	32 bit int.	-	R/W	sec	0	600
2168	Hysteresis	32 bit flo t	-	R/W	%	0	20
POWER FACTOR ALARM							
2170	Alarm relay	32 bit int.	S5	R/W	-	0	2
2172	Low limit	32 bit flo t	-	R/W	-	0	1
2174	High limit	32 bit flo t	-	R/W	-	0	1
2176	Alarm time	32 bit int.	-	R/W	sec	0	600
2178	Hysteresis	32 bit flo t	-	R/W	%	0	20
COSØ ALARM							
2180	Alarm relay	32 bit int.	S5	R/W	-	0	2
2182	Low limit	32 bit flo t	-	R/W	-	0	1
2184	High limit	32 bit flo t	-	R/W	-	0	1
2186	Alarm time	32 bit int.	-	R/W	sec	0	600
2188	Hysteresis	32 bit flo t	-	R/W	%	0	20
FREQUENCY ALARM							
2190	Alarm relay	32 bit int.	S5	R/W	-	0	2
2192	Low limit	32 bit flo t	-	R/W	Hz	35	70
2194	High limit	32 bit flo t	-	R/W	Hz	35	70
2196	Alarm time	32 bit int.	-	R/W	sec	0	600
2198	Hysteresis	32 bit flo t	-	R/W	%	0	20

Address	Parameter	Data Type	Descript.	R/W	Unit	Low Limit	High Limit
TEMPERATURE ALARM							
2200	Alarm relay	32 bit int.	S5	R/W	-	0	2
2202	Low limit	32 bit flo t	-	R/W	°C	-20	80
2204	High limit	32 bit flo t	-	R/W	°C	-20	80
2206	Alarm time	32 bit int.	-	R/W	sec	0	600
2208	Hysteresis	32 bit flo t	-	R/W	%	0	20
VOLTAGE HARMONICS ALARM							
2210	Alarm relay	32 bit int.	S5	R/W	-	0	2
2212	THD_High limit	32 bit flo t	-	R/W	%	0	100
2214	High limit harmonic 3	32 bit flo t	-	R/W	%	0	100
2216	High limit harmonic 5	32 bit flo t	-	R/W	%	0	100
2218	High limit harmonic 7	32 bit flo t	-	R/W	%	0	100
2220	High limit harmonic 9	32 bit flo t	-	R/W	%	0	100
2222	High limit harmonic 11	32 bit flo t	-	R/W	%	0	100
2224	High limit harmonic 13	32 bit flo t	-	R/W	%	0	100
2226	High limit harmonic 15	32 bit flo t	-	R/W	%	0	100
2228	High limit harmonic 17	32 bit flo t	-	R/W	%	0	100
2230	High limit harmonic 19	32 bit flo t	-	R/W	%	0	100
2232	High limit harmonic 21	32 bit flo t	-	R/W	%	0	100
2234	Alarm time	32 bit int.	-	R/W	sec	0	600
CURRENT HARMONICS ALARM							
2236	Alarm relay	32 bit int.	S5	R/W	%	0	2
2238	THD_High limit	32 bit flo t	-	R/W	%	0	100
2240	High limit harmonic 3	32 bit flo t	-	R/W	%	0	100
2242	High limit harmonic 5	32 bit flo t	-	R/W	%	0	100
2244	High limit harmonic 7	32 bit flo t	-	R/W	%	0	100
2246	High limit harmonic 9	32 bit flo t	-	R/W	%	0	100
2248	High limit harmonic 11	32 bit flo t	-	R/W	%	0	100
2250	High limit harmonic 13	32 bit flo t	-	R/W	%	0	100
2252	High limit harmonic 15	32 bit flo t	-	R/W	%	0	100
2254	High limit harmonic 17	32 bit flo t	-	R/W	%	0	100
2256	High limit harmonic 19	32 bit flo t	-	R/W	%	0	100
2258	High limit harmonic 21	32 bit flo t	-	R/W	%	0	100
2260	Alarm time	32 bit int.	-	R/W	sec	0	600
INDUCTIVE ENERGY ALARM (Qind./P)							
2262	High limit	32 bit flo t	-	R/W	%	0	40
2264	Alarm relay	32 bit int.	S5	R/W	-	0	2
CAPACITIVE ENERGY ALARM (Qcap./P)							
2266	High limit	32 bit flo t	-	R/W	%	0	40
2268	Alarm relay	32 bit int.	S5	R/W	-	0	2
STEP ALARM							
2270	Low limit	32 bit flo t	-	R/W	%	20	100

Address	Parameter	Data Type	Descript.	R/W	Unit	Low Limit	High Limit
MODE INPUT (DAY/NIGHT or GENERATOR)							
2272	Mode Input	32 bit int.	S11	R/W	-	0	2
CONNECTION LEARN SETTINGS							
2274	Learn conn. at start	32 bit int.	S13	R/W	-	0	1
2276	Learn conn. step number	32 bit int.	-	R/W	-	1	12
2278	Learn conn. retry timer	32 bit int.	-	R/W	sec	5	60
2280	Learn conn. retry count	32 bit int.	-	R/W	-	1	20
STEP LEARN SETTINGS							
2282	Learn steps at start	32 bit int.	S13	R/W	-	0	1
DEVICE SETTINGS							
2284	Language	32 bit int.	S7	R/W	-	0	1
2286	Contrast	32 bit int.	S8	R/W	-	0	8
2288	Password	32 bit int.	-	R/W	-	1	9999
2290	Password protection	32 bit int.	S12	R/W	-	1	9999
2292	DisplayOn	32 bit int.	S9	R/W	-	0	1
2294	DisplayTime	32 bit int.	-	R/W	sec	10	600
2296	SerialNumber	32 bit int.	-	RO	-	0	0
2298	FirmwareVer	32 bit flo t	-	RO	-	0	0
2300	Order Number	32 bit flo t	-	RO	-	0	0
2302	ConfigName	String	-	R/W	-	0	0
2314	DeviceName	String	-	R/W	-	0	0

Table 4-7 String List (Available for RAPIDUS 231R-E)

SL1	SL2	SL3	SL4	SL5	SL6	SL6
0)C	0-)1 - 1 - 1 - 1	0-Entered	0-Rapidus	0-Off	0)2400	0)Türkçe
1)L	1-)1 - 1 - 2 - 2	1-Predefined	1-Asc. Sequential	1-Relay1	1)4800	1)English
2)C1	2-)1 - 2 - 2 - 4	2-DCM	2-Des. sequential	2-Relay2	2)9600	2)Русский
3)C2	3-)1 - 2 - 3 - 3		3-Linear		3)19200	
4)C3	4-)1 - 2 - 4 - 4		4-Circular		4)38400	
5)L1	5-)1 - 1 - 2 - 4				5)57600	
6)L2	6-)1 - 2 - 3 - 4				6)115200	
7)L3	7-)1 - 2 - 4 - 8					
8)C1-2	8-)1 - 1 - 2 - 3					
9)C2-3						
10)L3-1						
11)L1-2						
12)L2-3						
13)L3-1						

S8	S9	S10	S11	S12	S13	S14
0-Level -4	0-Continuous	0-None	0-Off	0-Inactive	0-Off	0-Off
1-Level -3	1-Time dependent	1-Stage 1	1-Night/Day	1-Active	1-On	1-5 sec.
2-Level -2		2-Stage 1 and 2	2-Generator			2-10 sec.
3-Level -1		3-Stage 1, 2 and 3				3-20 sec.
4-Level 0						4-30 sec.
5-Level 1						5-40 sec.
6-Level 2						6-50 sec.
7-Level 3						7-60 sec.
8-Level 4						

4.5.2.2 Setting Parameters for RAPIDUS 232R-E

Table 4-8 Setting Parameter (Available for RAPIDUS 232R-E)

Address	Parameter	Data Type	Descript.	R/W	Unit	Low Limit	High Limit
NETWORK SETTINGS							
2000	Current Transf. Ratio (CTR)	32 bit flo t	-	R/W	-	1	5000
2002	Voltage Transf. Ratio (VTR)	32 bit flo t	-	R/W	-	1	5000
2004	Demand Period	32 bit int.	-	R/W	min.	1	60
ENERGY SETTINGS							
2006	Start of day	32 bit int.	-	R/W	hour	0	23
2008	Start of month	32 bit int.	-	R/W	-	1	28
2010	T1 kWh	32 bit flo t	-	R/W	kWh	0	20000000000.0
2012	T1 kWh E.	32 bit flo t	-	R/W	kWh	0	20000000000.0
2014	T1 kVArh I.	32 bit flo t	-	R/W	kVArh	0	20000000000.0
2016	T1 kVArh C.	32 bit flo t	-	R/W	kVArh	0	20000000000.0
STEP SETTINGS							
2018	Step1 power	32 bit flo t	-	R/W	kVArh	0	1000
2020	Step1 type	32 bit int.	S1	R/W	-	0	7
2022	Step2 power	32 bit flo t	-	R/W	kVArh	0	1000

Address	Parameter	Data Type	Descript.	R/W	Unit	Low Limit	High Limit
2024	Step2 type	32 bit int.	S1	R/W	-	0	7
2026	Step3 power	32 bit flo t	-	R/W	kVArh	0	1000
2028	Step3 type	32 bit int.	S1	R/W	-	0	7
2030	Step4 power	32 bit flo t	-	R/W	kVArh	0	1000
2032	Step4 type	32 bit int.	S1	R/W	-	0	7
2034	Step5 power	32 bit flo t	-	R/W	kVArh	0	1000
2036	Step5 type	32 bit int.	S1	R/W	-	0	7
2038	Step6 power	32 bit flo t	-	R/W	kVArh	0	1000
2040	Step6 type	32 bit int.	S1	R/W	-	0	7
2042	Step7 power	32 bit flo t	-	R/W	kVArh	0	1000
2044	Step7 type	32 bit int.	S1	R/W	-	0	7
2046	Step8 power	32 bit flo t	-	R/W	kVArh	0	1000
2048	Step8 type	32 bit int.	S1	R/W	-	0	7
2050	Step9 power	32 bit flo t	-	R/W	kVArh	0	1000
2052	Step9 type	32 bit int.	S1	R/W	-	0	7
2054	Step10 power	32 bit flo t	-	R/W	kVArh	0	1000
2056	Step10 type	32 bit int.	S1	R/W	-	0	7
2058	Step11 power	32 bit flo t	-	R/W	kVArh	0	1000
2060	Step11 type	32 bit int.	S1	R/W	-	0	7
2062	Step12 power	32 bit flo t	-	R/W	kVArh	0	1000
2064	Step12 type	32 bit int.	S1	R/W	-	0	7
2066	Step13 power	32 bit flo t	-	R/W	kVArh	0	1000
2068	Step13 type	32 bit int.	S1	R/W	-	0	7
2070	Step14 power	32 bit flo t	-	R/W	kVArh	0	1000
2072	Step14 type	32 bit int.	S1	R/W	-	0	7
2074	Step15 power	32 bit flo t	-	R/W	kVArh	0	1000
2076	Step15 type	32 bit int.	S1	R/W	-	0	7
2078	Step16 power	32 bit flo t	-	R/W	kVArh	0	1000
2080	Step16 type	32 bit int.	S1	R/W	-	0	7
2082	Step17 power	32 bit flo t	-	R/W	kVArh	0	1000
2084	Step17 type	32 bit int.	S1	R/W	-	0	7
2086	Step18 power	32 bit flo t	-	R/W	kVArh	0	1000
2088	Step18 type	32 bit int.	S1	R/W	-	0	7
2090	Step19 power	32 bit flo t	-	R/W	kVArh	0	1000
2092	Step19 type	32 bit int.	S1	R/W	-	0	7
2094	Step20 power	32 bit flo t	-	R/W	kVArh	0	1000
2096	Step20 type	32 bit int.	S1	R/W	-	0	7
2098	Step21 power	32 bit flo t	-	R/W	kVArh	0	1000
2100	Step21 type	32 bit int.	S1	R/W	-	0	7
2102	Step22 power	32 bit flo t	-	R/W	kVArh	0	1000
2104	Step22 type	32 bit int.	S1	R/W	-	0	7
2106	Step23 power	32 bit flo t	-	R/W	kVArh	0	1000
2108	Step23 type	32 bit int.	S1	R/W	-	0	7
2110	Step24 power	32 bit flo t	-	R/W	kVArh	0	1000
2112	Step24 type	32 bit int.	S1	R/W	-	0	7

Address	Parameter	Data Type	Descript.	R/W	Unit	Low Limit	High Limit
2114	Bank structure	32 bit int.	S2	R/W	-	0	8
2116	Bank power	32 bit flo t	-	R/W	kVArh	0	1000
2118	Bank count	32 bit int.	-	R/W	-	0	24
2120	Discharge time	32 bit int.	-	R/W	sec	3	1000
COMPENSATION SETTINGS							
2122	Steps	32 bit int.	S3	R/W	-	0	1
2124	Program	32 bit int.	S4	R/W	-	0	4
2126	Target 1	32 bit flo t	-	R/W	-	-0.800	0.800
2128	Target 2	32 bit flo t	-	R/W	-	0.000	1.000
2130	Target low limit	32 bit flo t	-	R/W	-	0.000	0.200
2132	Target high limit	32 bit flo t	-	R/W	-	0.000	0.200
2134	Activation time	32 bit int.	-	R/W	sec	1	600
2136	Deactivation time	32 bit int.	-	R/W	sec	1	600
2138	Shift angle	32 bit flo t	-	R/W	-	-45	45
2140	Fixed steps	32 bit int.	S10	R/W	-	0	3
2142	Averaging time	32 bit int.	S14	R/W	-	0	7
COMMUNICATION SETTINGS							
2144	BaudRate	32 bit int.	S6	R/W	-	0	6
2146	Slaveld	32 bit int.	-	R/W	-	1	247
ALARM SETTINGS							
VOLTAGE (L-N) ALARM							
2148	Alarm relay	32 bit int.	S5	R/W	-	0	2
2150	Low limit	32 bit flo t	-	R/W	V	0	1500000
2152	High limit	32 bit flo t	-	R/W	V	0	1500000
2154	Alarm time	32 bit int.	-	R/W	sec	0	600
2156	Hysteresis	32 bit flo t	-	R/W	%	0	20
VOLTAGE (L-L) ALARM							
2158	Alarm relay	32 bit int.	S5	R/W	-	0	2
2160	Low limit	32 bit flo t	-	R/W	V	0	2600000
2162	High limit	32 bit flo t	-	R/W	V	0	2600000
2164	Alarm time	32 bit int.	-	R/W	sec	0	600
2166	Hysteresis	32 bit flo t	-	R/W	%	0	20
CURRENT ALARM							
2168	Alarm relay	32 bit int.	S5	R/W	-	0	2
2170	Low limit	32 bit flo t	-	R/W	A	0	30000
2172	High limit	32 bit flo t	-	R/W	A	0	30000
2174	Alarm time	32 bit int.	-	R/W	sec	0	600
2176	Hysteresis	32 bit flo t	-	R/W	%	0	20
ACTIVE POWER ALARM							
2178	Alarm relay	32 bit int.	S5	R/W	-	0	2
2180	Low limit	32 bit flo t	-	R/W	W	-1E+10	10000000000
2182	High limit	32 bit flo t	-	R/W	W	-1E+10	10000000000
2184	Alarm time	32 bit int.	-	R/W	sec	0	600
2186	Hysteresis	32 bit flo t	-	R/W	%	0	20

Address	Parameter	Data Type	Descript.	R/W	Unit	Low Limit	High Limit
REACTIVE POWER ALARM							
2188	Alarm relay	32 bit int.	S5	R/W	-	0	2
2190	Low limit	32 bit flo t	-	R/W	VAr	-1E+10	10000000000
2192	High limit	32 bit flo t	-	R/W	VAr	-1E+10	10000000000
2194	Alarm time	32 bit int.	-	R/W	sec	0	600
2196	Hysteresis	32 bit flo t	-	R/W	%	0	20
APPARENT POWER ALARM							
2198	Alarm relay	32 bit int.	S5	R/W	-	0	2
2200	Low limit	32 bit flo t	-	R/W	A	0	30000
2202	High limit	32 bit flo t	-	R/W	A	0	30000
2204	Alarm time	32 bit int.	-	R/W	sec	0	600
2206	Hysteresis	32 bit flo t	-	R/W	%	0	20
NEUTRAL CURRENT ALARM							
2208	Alarm relay	32 bit int.	S5	R/W	-	0	2
2210	Low limit	32 bit flo t	-	R/W	-	0	1
2212	High limit	32 bit flo t	-	R/W	-	0	1
2214	Alarm time	32 bit int.	-	R/W	sec	0	600
2216	Hysteresis	32 bit flo t	-	R/W	%	0	20
POWER FACTOR ALARM							
2218	Alarm relay	32 bit int.	S5	R/W	-	0	2
2220	Low limit	32 bit flo t	-	R/W	-	0	1
2222	High limit	32 bit flo t	-	R/W	-	0	1
2224	Alarm time	32 bit int.	-	R/W	sec	0	600
2226	Hysteresis	32 bit flo t	-	R/W	%	0	20
COSØ ALARM							
2228	Alarm relay	32 bit int.	S5	R/W	-	0	2
2230	Low limit	32 bit flo t	-	R/W	-	0	1
2232	High limit	32 bit flo t	-	R/W	-	0	1
2234	Alarm time	32 bit int.	-	R/W	sec	0	600
2236	Hysteresis	32 bit flo t	-	R/W	%	0	20
FREQUENCY ALARM							
2238	Alarm relay	32 bit int.	S5	R/W	-	0	2
2240	Low limit	32 bit flo t	-	R/W	Hz	35	70
2242	High limit	32 bit flo t	-	R/W	Hz	35	70
2244	Alarm time	32 bit int.	-	R/W	sec	0	600
2246	Hysteresis	32 bit flo t	-	R/W	%	0	20
TEMPERATURE ALARM							
2248	Alarm relay	32 bit int.	S5	R/W	-	0	2
2250	Low limit	32 bit flo t	-	R/W	°C	-20	80
2252	High limit	32 bit flo t	-	R/W	°C	-20	80
2254	Alarm time	32 bit int.	-	R/W	sec	0	600
2256	Hysteresis	32 bit flo t	-	R/W	%	0	20

Address	Parameter	Data Type	Descript.	R/W	Unit	Low Limit	High Limit
VOLTAGE HARMONICS ALARM							
2258	Alarm relay	32 bit int.	S5	R/W	-	0	2
2260	THD_High limit	32 bit flo t	-	R/W	%	0	100
2262	High limit harmonic 3	32 bit flo t	-	R/W	%	0	100
2264	High limit harmonic 5	32 bit flo t	-	R/W	%	0	100
2266	High limit harmonic 7	32 bit flo t	-	R/W	%	0	100
2268	High limit harmonic 9	32 bit flo t	-	R/W	%	0	100
2270	High limit harmonic 11	32 bit flo t	-	R/W	%	0	100
2272	High limit harmonic 13	32 bit flo t	-	R/W	%	0	100
2274	High limit harmonic 15	32 bit flo t	-	R/W	%	0	100
2276	High limit harmonic 17	32 bit flo t	-	R/W	%	0	100
2278	High limit harmonic 19	32 bit flo t	-	R/W	%	0	100
2280	High limit harmonic 21	32 bit flo t	-	R/W	%	0	100
2282	Alarm time	32 bit int.	-	R/W	sec	0	600
CURRENT HARMONICS ALARM							
2284	Alarm relay	32 bit int.	S5	R/W	%	0	2
2286	THD_High limit	32 bit flo t	-	R/W	%	0	100
2288	High limit harmonic 3	32 bit flo t	-	R/W	%	0	100
2290	High limit harmonic 5	32 bit flo t	-	R/W	%	0	100
2292	High limit harmonic 7	32 bit flo t	-	R/W	%	0	100
2294	High limit harmonic 9	32 bit flo t	-	R/W	%	0	100
2296	High limit harmonic 11	32 bit flo t	-	R/W	%	0	100
2298	High limit harmonic 13	32 bit flo t	-	R/W	%	0	100
2300	High limit harmonic 15	32 bit flo t	-	R/W	%	0	100
2302	High limit harmonic 17	32 bit flo t	-	R/W	%	0	100
2304	High limit harmonic 19	32 bit flo t	-	R/W	%	0	100
2306	High limit harmonic 21	32 bit flo t	-	R/W	%	0	100
2308	Alarm time	32 bit int.	-	R/W	sec	0	600
INDUCTIVE ENERGY ALARM (Qind./P)							
2310	High limit	32 bit flo t	-	R/W	%	0	40
2312	Alarm relay	32 bit int.	S5	R/W	-	0	2
CAPACITIVE ENERGY ALARM (Qcap./P)							
2314	High limit	32 bit flo t	-	R/W	%	0	40
2316	Alarm relay	32 bit int.	S5	R/W	-	0	2

Address	Parameter	Data Type	Descript.	R/W	Unit	Low Limit	High Limit
MODE INPUT (DAY/NIGHT or GENERATOR)							
2318	Mode Input	32 bit int.	S11	R/W	-	0	2
CONNECTION LEARN SETTINGS							
2320	Learn conn. at start	32 bit int.	S13	R/W	-	0	1
2322	Learn conn. step number	32 bit int.	-	R/W	-	1	12
2324	Learn conn. retry timer	32 bit int.	-	R/W	sec	5	60
2326	Learn conn. retry count	32 bit int.	-	R/W	-	1	20
STEP LEARN SETTINGS							
2328	Learn steps at start	32 bit int.	S13	R/W	-	0	1
DEVICE SETTINGS							
2330	Language	32 bit int.	S7	R/W	-	0	1
2332	Contrast	32 bit int.	S8	R/W	-	0	8
2334	Password	32 bit int.	-	R/W	-	1	9999
2336	Password protection	32 bit int.	S12	R/W	-	0	1
2338	DisplayOn	32 bit int.	S9	R/W	-	0	1
2340	DisplayTime	32 bit int.	-	R/W	sec	10	600
2342	SerialNumber	32 bit int.	-	RO	-	0	0
2344	FirmwareVer	32 bit flo t	-	RO	-	0	0
2346	Order Number	32 bit flo t	-	RO	-	0	0
2348	ConfigName	String	-	R/W	-	0	0
2360	DeviceName	String	-	R/W	-	0	0

Table 4-9 String List (Available for RAPIDUS 232R-E)

SL1	SL2	SL3	SL4	SL5	SL6	SL6
0)C	0-)1 - 1 - 1 - 1	0-Entered	0-Rapidus	0-Off	0)2400	0)Türkçe
1)L	1-)1 - 1 - 2 - 2	1-Predefined	1-Asc. Sequential	1-Relay1	1)4800	1)English
2)C1	2-)1 - 2 - 2 - 4		2-Des. sequential	2-Relay2	2)9600	2)Русский
3)C2	3-)1 - 2 - 3 - 3		3-Linear		3)19200	
4)C3	4-)1 - 2 - 4 - 4		4-Circular		4)38400	
5)L1	5-)1 - 1 - 2 - 4				5)57600	
6)L2	6-)1 - 2 - 3 - 4				6)115200	
7)L3	7-)1 - 2 - 4 - 8					
8)C1-2	8-)1 - 1 - 2 - 3					
9)C2-3						
10)L3-1						
11)L1-2						
12)L2-3						
13)L3-1						

S8	S9	S10	S11	S12	S13	S14
0-Level -4	0-Continuous	0-None	0-Off	0-Inactive	0-Off	0-Off
1-Level -3	1-Time	1-Stage 1	1-Night/Day	1-Active	1-On	1-5 sec.
2-Level -2	dependent	2-Stage 1 and 2	2-Generator			2-10 sec.
3-Level -1		3-Stage 1, 2				3-20 sec.
4-Level 0		and 3				4-30 sec.
5-Level 1						5-40 sec.
6-Level 2						6-50 sec.
7-Level 3						7-60 sec.
8-Level 4						

EXAMPLE:

If slave ID is assigned as 157;

Request		RAPIDUS Response	
Slave ID	01h	Slave ID	01h
Function code	10h	Function code	10h
Starting address (high)	08h	Starting address (high)	08h
Starting address (low)	26h	Starting address (low)	26h
Number of registers (high)	00h	Number of registers (high)	00h
Number of registers (low)	02h	Number of registers (low)	02h
Number of bytes	04h	CRC (high)	A2h
Register value (high)	00h	CRC (low)	63h
Register value (low)	00h		
Register value (high)	00h		
Register value (low)	9Dh		
CRC (high)	D7h		
CRC (low)	F4h		



4.5.3 ARCHIVE (HISTORY) RECORDS

RAPIDUS archive records consist of blocks having 68 parameters. Each parameter inside the archive block is a 32 bit length variable. Archive data block is as shown in Table 4-10.

The programmer will access archive by implementing “0x14 - Read File Record” function. “0x14 - Read File Record” function accesses the data with “file numbers”.

For RAPIDUS,

File numbers 1 – 1920 are used to access HOURLY data.

File numbers 5001- 5240 are used to access DAILY data.

File numbers 10001-10036 are used to access MONTHLY data.

- The last saved file number in the hourly data memory for RAPIDUS 231R-E; can be accessed from 984 modbus addressed parameter ([Refer to Table 4-4](#)).
- The last saved file number in the hourly data memory for RAPIDUS 232R-E; can be accessed from 1032 modbus addressed parameter ([Refer to Table 4-5](#)).

- The last saved file number in the daily data memory for RAPIDUS 231R-E; can be accessed from 986 modbus addressed parameter ([Refer to Table 4-4](#)).
- The last saved file number in the daily data memory for RAPIDUS 232R-E; can be accessed from 1034 modbus addressed parameter ([Refer to Table 4-5](#)).

- The last saved file number in the monthly data memory for RAPIDUS 231R-E; can be accessed from 988 modbus addressed parameter ([Refer to Table 4-4](#)).
- The last saved file number in the monthly data memory for RAPIDUS 232R-E; can be accessed from 1036 modbus addressed parameter ([Refer to Table 4-5](#)).

Table 4-10 Archive (History) Record Table

Item No.	History Records	Variable Type
1	Time Info (Timestamp)	32 bit int.
2	L1 average voltage value (V ave.)	32 bit flo t
3	L1 minimum voltage value (V1 min.)	32 bit flo t
4	L1 maximum voltage value (V1 max.)	32 bit flo t
5	L1 average current value (I1 ave.)	32 bit flo t
6	L1 minimum current value (I1 min.)	32 bit flo t
7	L1 maximum current value (I1 max.)	32 bit flo t
8	L1 average active power value (P1 ave.)	32 bit flo t
9	L1 minimum active power value (P1 min.)	32 bit flo t
10	L1 maximum active power value (P1 max.)	32 bit flo t
11	L1 average reactive power value (Q1 ave.)	32 bit flo t
12	L1 minimum reactive power value (Q1 min.)	32 bit flo t
13	L1 maximum reactive power value (Q1 max..)	32 bit flo t
14	L1 average apparent power value (S1 ave.)	32 bit flo t
15	L1 minimum apparent power value (S1 min.)	32 bit flo t
16	L1 maximum apparent power value (S1 max.)	32 bit flo t



Item No.	History Records	Variable Type
17	L1 average $\cos\phi$ value ($\cos\phi 1$ ave.)	32 bit flo t
18	L1 average PF value (PF1 ave.)	32 bit flo t
19	L2 average voltage value (V2 ave.)	32 bit flo t
20	L2 minimum voltage value(V2 min.)	32 bit flo t
21	L2 maximum voltage value(V2 max.)	32 bit flo t
22	L2 average current value (I2 ave.)	32 bit flo t
23	L2 minimum current value (I2 min.)	32 bit flo t
24	L2 maximum current value (I2 max.)	32 bit flo t
25	L2 average active power value (P2 ave.)	32 bit flo t
26	L2 minimum active power value (P2 min.)	32 bit flo t
27	L2 maximum active power value (P2 max.)	32 bit flo t
28	L2 average reactive power value (Q2 ave.)	32 bit flo t
29	L2 minimum reactive power value (Q2 min.)	32 bit flo t
30	L2 maximum reactive power value (Q2 max..)	32 bit flo t
31	L2 average apparent power value (S2 ave.)	32 bit flo t
32	L2 minimum apparent power value (S2 min.)	32 bit flo t
33	L2 maximum apparent power value (S2 max.)	32 bit flo t
34	L2 average $\cos\phi$ value ($\cos\phi 2$ ave.)	32 bit flo t
35	L2 average PF value (PF2 ave.)	32 bit flo t
36	L3 average voltage value (V3 ave.)	32 bit flo t
37	L3 minimum voltage value (V3 min.)	32 bit flo t
38	L3 maximum voltage value (V3 max.)	32 bit flo t
39	L3 average current value (I3 ave.)	32 bit flo t
40	L3 minimum current value (I3 min.)	32 bit flo t
41	L3 maximum current value (I3 max.)	32 bit flo t
42	L3 average active power value (P3 ave.)	32 bit flo t
43	L3 minimum active power value (P3 min.)	32 bit flo t
44	L3 maximum active power value (P3 max.)	32 bit flo t
45	L3 average reactive power value (Q3 ave.)	32 bit flo t
46	L3 minimum reactive power value (Q3 min.)	32 bit flo t
47	L3 maximum reactive power value (Q3 max..)	32 bit flo t
48	L3 average apparent power value (S3 ave.)	32 bit flo t
49	L3 minimum apparent power value (S3 min.)	32 bit flo t
50	L3 maximum apparent power value (S3 max.)	32 bit flo t
51	L3 average $\cos\phi$ value ($\cos\phi 3$ ave.)	32 bit flo t
52	L3 average PF value (PF3 ave.)	32 bit flo t
53	V12 voltage average value (V12 ave.)	32 bit flo t
54	V12 voltage minimum value (V12 min.)	32 bit flo t
55	V12 voltage maximum value (V12 max.)	32 bit flo t
56	V23 voltage average value (V23 ave.)	32 bit flo t
57	V23 voltage minimum value (V23 min.)	32 bit flo t
58	V23 voltage maximum value (V23 max.)	32 bit flo t



Item No.	History Records	Variable Type
59	V31 voltage average value (V31 ave.)	32 bit flo t
60	V31 voltage minimum value (V31 min.)	32 bit flo t
61	V31 voltage maximum value (V31 max.)	32 bit flo t
62	L1 average frequency value (F1 ave.)	32 bit flo t
63	L1 minimum frequency value (F1 min.)	32 bit flo t
64	L1 maximum frequency value (F1 max.)	32 bit flo t
65	T1 meters consumed-imp. active energy value (T1 kWh)	32 bit flo t
66	T1 meters generated-exp. active energy value (T1 kWh E.)	32 bit flo t
67	T1 meters inductive reactive energy value	32 bit flo t
68	T1 meters capacitive reactive energy value	32 bit flo t

4.5.3.1 Hourly archive data

The smallest and largest instantaneous values measured during one hour period, are saved as minimum and maximum values. Likewise, average values of measurements, which were taken in one hour period, are saved as average values.

14h function operates with file numbers. File numbers between 1 – 1920 are used for HOURLY data.



All data is deleted when 1920 hourly records are filled. 1921st data will be the first data of the related memory and the file number will be 1.

Rapidus has a memory that is reserved for hourly files. It can keep totally 1920 hourly files.

Assume that, reserved memory for hourly files are filled completely. In this case, the last saved file number will be "1920" and user can access this number with querying 984th modbus address for RAPIDUS 231R-E (Refer to table 4-4). and 1032nd modbus address for RAPIDUS 232R-E (Refer to table 4-5).

EXAMPLE:

Assume that a programmer will try to access a RAPIDUS with a slave ID number 1. Assume also that the last saved hourly file number of this device is 17. In this case, data request and RAPIDUS response will be as follows:

Query	
Slave ID	0x01
Function code	0x14
Byte Counts	0x07
Sub-req. 1 reference type	0x06
Sub-req. 1 file number HI	0x00
Sub-req. 1 file number LO	0x11
Sub-req. 1 starting reg. addr. HI	0x00
Sub-req. 1 starting reg. addr. LO	0x00
Sub-req. 1 register count HI	0x00
Sub-req. 1 register count LO	0x0A
CRC HI	0xB3
CRC LO	0xD4

Rapidus Response	
Slave ID	0x01
Function code	0x14
Byte count	0x16
Sub-req. 1 byte count	0x15
Sub-req. 1 reference type	0x06
Timestamp	XXX
Timestamp	XXX
Timestamp	XXX
Timestamp	XXX

CRC HI	XXX
CRC LO	XXX

The parameters and CRC values in above tables, are as they should be. On the other hand, Rapidus response is given to describe the message structure. As a result, values for variables are not defined.



4.5.3.2 Daily archive data

Recording of daily data changes with start of day ([Refer to 3.2.1.2.6.1](#)) setting.

The smallest and largest instantaneous values measured during one day period, are saved as minimum and maximum values. Likewise, average values of measurements, which were taken in one day period, are saved as average values.

14h function operates with file numbers. File numbers 5001 – 5240 are used for DAILY data.

Rapidus has a memory that is reserved for daily files. It can keep totally 240 daily files.



All data is deleted when 240 daily records are filled. 241st data will be the first data of the related memory and the file number will be 1.

The 'last saved file number' inside the daily memory can be accessed from the 32-bit parameter starting from Modbus address 986 for RAPIDUS 231R-E ([Refer to table 4-4](#)) and Modbus address 1034 for RAPIDUS 232R-E ([Refer to Table 4-5](#))

4.5.3.3 Monthly archive data

Recording of daily data changes with start of month ([Refer to 3.2.1.2.6.2](#)) and start of day ([Refer to 3.2.1.2.6.1](#)) settings.

The smallest and largest instantaneous values measured during one month period, are saved as minimum and maximum values. Likewise, average values of measurements, which were taken in one month period, are saved as average values.

14h function operates with file numbers. File numbers 10001 – 10036 are used for MONTHLY data.

Rapidus has a memory that is reserved for monthly files. It can keep totally 36 monthly files.



All data is deleted when 36 monthly records are filled. 37th data will be the first data of the related memory and the file number will be 1.

The 'last saved file number' inside the daily memory can be accessed from the 32-bit parameter starting from Modbus address 988 for RAPIDUS 231R-E ([Refer to table 4-4](#)) and Modbus address 1036 for RAPIDUS 232R-E ([Refer to Table 4-5](#))



4.5.4 Clear(Common for RAPIDUS 231R-E and RAPIDUS 232R-E)

Operator/programmer can erase/zeroize data stored in non-volatile memory via MODBUS commands. Erasable data are as follows:

- energy meters
- demand values
- all variables mentioned above
- hourly archive records
- daily archive records
- monthly archive records
- alarm records

Table 4-11 Clear Address Table

Address	Data Type	Parameters/Records to be Cleared	R/W	Value	Modbus func.
1900	32 bit int.	Energy meters	W	1	10H-06H
1902	32 bit int.	Demand values	W	1	10H-06H
1906	32 bit int.	All variables above	W	1	10H-06H
1910	32 bit int.	Hourly archive records	W	1	10H-06H
1912	32 bit int.	Daily archive records	W	1	10H-06H
1914	32 bit int.	Monthly archive records	W	1	10H-06H
1916	32 bit int.	Alarm records	W	1	10H-06H
In order to complete to erase/zeroize, programmer should write 1 to the below MODBUS address:					
1898	32 bit int.	Complete erasing/zeroizing	W	1	10H-06H



In order to complete clearing process, operator/programmer should:

- Write "1" to registers related with 'to be cleared parameters'
- Then, write 0 to 1898 register, and 1 to 1899 register, "within 60 seconds".



RAPIDUS

Power Factor
Controller

**SECTION 5
FACTORY
PRESETS**



SECTION 5 FACTORY PRESETS

	Factory Presets	Unit	Setting Values
Network Settings			
CTR	1	-	1↔5000
VTR	1	-	1.0↔5000.0
Demand Period	15	min	1↔60
Step Settings			
Ent. Power	10	kVAr	0.00↔1000.00
Ent. Type	C	-	C, L, C1, C2, C3, L1, L2, L3, C1-2, C2-3, C3-1, L1-2, L2-3, L3-1 Note: C1-2, C2-3, C3-1, L1-2, L2-3 and L3-1 are available only for 12 step version.
Predefined Structure	1-1-1-1	-	1-1-1-1, 1-1-2-2, 1-2-2-4, 1-2-3-3, 1-2-4-4, 1-1-2-4, 1-2-3-4, 1-2-4-8, 1-1-2-3
Predefined Power	10	kVAr	0.00↔1000.00
Number of Predefined Steps	12	-	1↔12 / 1↔24
Discharge Time	15	s	3↔1000
Compensation Settings			
Steps	Entered	-	Entered, Predefined
Program	Rapidus	-	Rapidus, Ascending Sequential, Descending Sequential, Linear, Circular, Manual
Target 1	1.000	-	-0.800↔0.800
Target 2	0.900	-	0.800↔1.000
Target low limit	0.002	-	0.000↔0.200
Target high limit	0.002	-	0.000↔0.200

	Factory Presets	Unit	Setting Values
Activation Time	10	s	1↔500
Deactivation Time	10	s	1↔500
Shift Angle	0.00	°	-45.00 ↔ 45.00 °
Averaging Time	Off	s	Off 5 s, 10 s, 20 s, 30 s, 40 s, 50 s, 60 s
Fixed Steps	N/A	-	N/A, Step 1, Step 1 and 2, Step 1,2 and 3
Learn Settings			
Connection	Off	-	Off On
Step number	1	-	1↔12
Retry Time	5	min	5↔60
Retry Number	3	-	1↔20
Learn Step	Off	-	Off On
Digital Input Settings			
Mode	Off	-	Off Night/Day, Generator
Device Settings			
Language	English	-	English, Türkçe, Русский
Contrast	Level 0	-	Level 4↔Level -4
Pass. Protection	On	-	Off On
New Password	1	-	1↔9999
Display On	Time Dependent	-	Time Dependent, Continuous
Display On Time	600	s	10↔600
Energy Settings			
Start of Day	0	h	0↔23
Start of Month	1		1↔28
kWh	1000000.000	kWh	0.0↔20000000000.0
kWh E.	1000000.000	kWh	0.0↔20000000000.0
kVArh I.	1000000.000	kVArh	0.0↔20000000000.0
kVArh C.	1000000.000	kVArh	0.0↔20000000000.0
Communication Settings			
Baud Rate	38400	bps	2400, 4800, 9600, 19200, 38400, 57600 115200
Slave Id	1	-	1↔247

	Factory Presets	Unit	Setting Values
Alarm Settings			
Energy			
Inductive Hi Limit	20.0	%	0.0↔40.0
Alarm Relay	Off	-	Off Relay1, Relay2
Capacitive Hi Limit	15.0	%	0.0↔40.0
Alarm Relay	Off	-	Off Relay1, Relay2
V (L-N)			
Alarm Relay	Off	-	Off Relay1, Relay2
Low Limit	0.0	V	0.0↔1500000
High Limit	0.0	V	0.0↔1500000
Delay	0	s	0↔600
Hysteresis	0.0	%	0.0↔20
V (L-L)			
Alarm Relay	Off	-	Off Relay1, Relay2
Low Limit	0.0	V	0.0↔2600000
High Limit	0.0	V	0.0↔2600000
Delay	0	s	0↔600
Hysteresis	0.0	%	0.0↔20
Current, IN			
Alarm Relay	Off	-	Off Relay1, Relay2
Low Limit	0.0	A	0.0↔30000.0
High Limit	0.0	A	0.0↔30000.0
Delay	0	s	0↔600
Hysteresis	0.0	%	0.0↔20
P			
Alarm Relay	Off	-	Off Relay1, Relay2
Low Limit	0.0	W	-1000000000.0↔10000000000.0
High Limit	0.0	W	-1000000000.0↔10000000000.0
Delay	0	s	0↔600
Hysteresis	0.0	%	0.0↔20
Q			
Alarm Relay	Off	-	Off Relay1, Relay2
Low Limit	0.0	VAr	-1000000000.0↔10000000000.0
High Limit	0.0	VAr	-1000000000.0↔10000000000.0
Delay	0	s	0↔600

	Factory Presets	Unit	Setting Values
Hysteresis	0.0	%	0.0↔20
S			
Alarm Relay	Off	-	Off Relay1, Relay2
Low Limit	0.0	VA	0.0↔10000000000.0
High Limit	0.0	VA	0.0↔10000000000.0
Delay	0	s	0↔600
Hysteresis	0.0	%	0.0↔20
CosØ, PF			
Alarm Relay	Off	-	Off Relay1, Relay2
Low Limit	0.000	-	0.000↔1.000
High Limit	0.000	-	0.000↔1.000
Delay	0	s	0↔600
Hysteresis	0.0	%	0.0↔20
Step			
Low Limit	20.0	-	20.0↔100.0
F			
Alarm Relay	Off	-	Off Relay1, Relay2
Low Limit	50.0	Hz	45.0↔65.0
High Limit	50.0	Hz	45.0↔65.0
Delay	0	s	0↔600
Hysteresis	0.0	%	0.0↔20
Harmonics V			
Alarm Relay	Off	-	Off Relay1, Relay2
THDV Hi Limit	0.0	%	0.0↔100.0
V3 Hi Limit	0.0	%	0.0↔100.0
V5 Hi Limit	0.0	%	0.0↔100.0
V7 Hi Limit	0.0	%	0.0↔100.0
V9 Hi Limit	0.0	%	0.0↔100.0
V11 Hi Limit	0.0	%	0.0↔100.0
V13 Hi Limit	0.0	%	0.0↔100.0
V15 Hi Limit	0.0	%	0.0↔100.0
V17 Hi Limit	0.0	%	0.0↔100.0
V19 Hi Limit	0.0	%	0.0↔100.0
V21 Hi Limit	0.0	%	0.0↔100.0
Harmonics I			
Alarm Relay	Off	-	Off Relay1, Relay2
THDI Hi Limit	0.0	%	0.0↔100.0

	Factory Presets	Unit	Setting Values
I3 Hi Limit	0.0	%	0.0↔100.0
I5 Hi Limit	0.0	%	0.0↔100.0
I7 Hi Limit	0.0	%	0.0↔100.0
I9 Hi Limit	0.0	%	0.0↔100.0
I11 Hi Limit	0.0	%	0.0↔100.0
I13 Hi Limit	0.0	%	0.0↔100.0
I15 Hi Limit	0.0	%	0.0↔100.0
I17 Hi Limit	0.0	%	0.0↔100.0
I19 Hi Limit	0.0	%	0.0↔100.0
I21 Hi Limit	0.0	%	0.0↔100.0
Temperature			
Alarm Relay	Off	-	Off Relay1, Relay2
Low Limit	0.0	°C	-20.0 °C ↔55 °C
High Limit	0.0	°C	-20.0 °C ↔55 °C
Delay	0	s	0↔600
Hysteresis	0.0	%	0.0↔20.0



RAPIDUS

Power Factor
Controller

**SECTION 6
TECHNICAL
SPECIFICATIONS**

SECTION 6 TECHNICAL SPECIFICATIONS

Supply

Voltage(from V1-N)..... 95..272VAC RMS $\pm 10\%$

Frequency.....45-65 Hz

Measurement Inputs

CATIII

Voltage..... 95..272VAC $\pm 10\%$ (L-N)

164..471VAC $\pm 10\%$ (L-L)

Current..... 0.01..6 A RMS

Frequency..... 45..65 Hz

Night/Day Input..... 95.. 240 VAC RMS

(85..265VAC RMS including tolerances)

Measurement Accuracy

Function Symbol	Function	Function Performance Class According to IEC 61557-12	Measuring Range	Other Complementary Characteristics
P	Total active power	0,2	1 % $I_n \leq I \leq I_{max}$ 0,5 Ind to 0,8 Cap	-
Q_V	Total reactive power	1	2 % $I_n \leq I \leq I_{max}$ 0,25 Ind to 0,25 Cap	-
S_A	Total apparent power	0,2	2 % $I_n \leq I \leq I_{max}$	-
E_A	Total active energy	0,2	0 to 49999999999	IEC 62053-22 Class 0.25
E_{rV}	Total reactive energy	2	0 to 49999999999	IEC 62053-23 Class 2
f	Frequency	0,05	45 – 65 Hz	-
I	Phase current	0,2	10 % $I_n \leq I \leq I_{max}$	-
I_{Nc}	Neutral current (calculated)	0,5	10 % $I_n \leq I \leq I_{max}$	-
U	Voltage	0,2	$U_{min} \leq U \leq U_{max}$	-
PF_A	Power factor	0,5	0,5 Ind to 0,8 Cap	-
THDV	Total harmonic distortion voltage	1	0 % to 20 %	-
THDI	Total harmonic distortion current	1	0 % to 100 %	-

Relay Outputs for Compensation

12/24 pcs.,

Max. switching voltage : 250 VAC

Max. switchig current..... : 2 A

Alarm Relay Outputs:

2 pcs,

Max. switching current.....: 4A

Max. switching voltage: 250 VAC

Max. switching power..... : 1250 VA

**Number of Steps**

Can be selected between 1-12/1-24.

Target Cos ϕ Interval

-0.800-0.800 can be selected with 0.001 steps.

CTR

Can be set 1..5000.

VTR

Can be set 1..5000.

Demand Period

Can be set 1 to 60 minutes.

User Interface

Keypad: 6 keys with ESD protection

LCD: Self-illuminated 160 x 240 graphic

Communication

Isolated RS485 Port.....:1 Channel, ESD and over current/voltage protected,
programmable, 2400bps to 115200 bps baud rate.
2000VRMS isolation.

Operating Temperature

-20°C..+55°C

Storage Temperature

-30°C..+80°C

Relative Humidity

Maximum 95% No Condensation

Dimensions

W144 x H144 x D78

Protection class

IP40 front, IP20 rear

Power Consumption

<10VA

