

Klemsan[®]



FUSE TERMINAL BLOCK
ASK 5 / ASK 5 LD

FUSE TERMINAL BLOCK

ASK 5 SERIES:

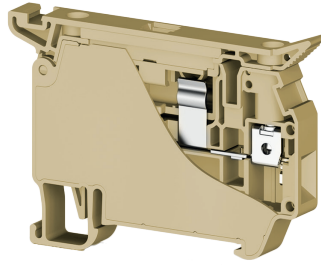
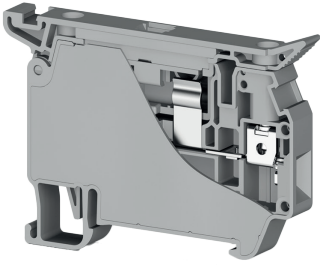

353 409

353 400

iReach An Upper Level Of Nominal Current! **10 A**

The **ASK 5** series fuse terminal blocks can be used with **5x20-5x25mm** glass fuse, it produced as closed type so there is no need to use an extra end plate. The **ASK 5** series supports up to **10 Amp.** of nominal current. This value is higher than the market average, which is **6.3 Amp.**

SAVE TIME IN THE INSTALLATION

UK SERIES CROSS CONNECTORS

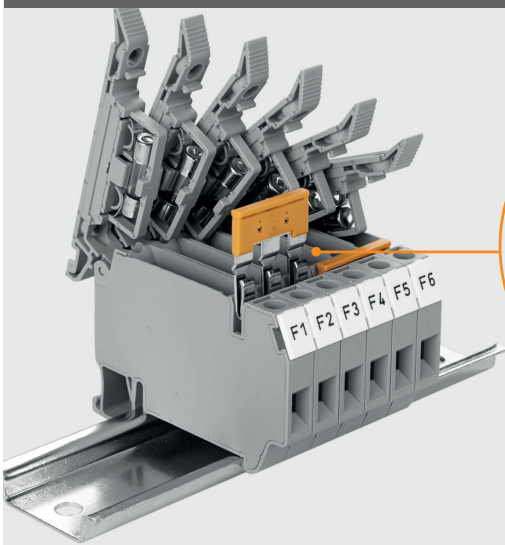

UK SERIES

The innovative design allows the connection of common points with the UK Series cross connectors.

Improve your wiring techniques avoiding the connection of two and more wires in the same cable location. ➔

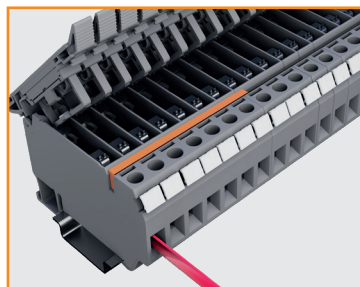

FUSE TERMINAL BLOCK

ASK 5 LD SERIES:

ASK 5 LD Series fuse terminal block can be chosen for easier identification of open fuses thanks to the LED option. Select the right terminal block from the range of voltage levels : 24V, 110V and 220V, according to your needs.

Reduce the interferences produced by electromagnetic fields.

ASK 5LD 24 V AC/DC	353 429	50
ASK 5LD 110 V AC/DC	353 449	50
ASK 5LD 220 V AC/DC	353 439	50

Outdated versions

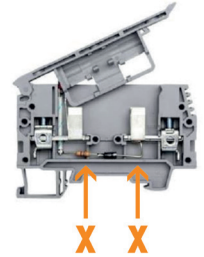

Thanks to the design, ASK 5 series with LED, has a built-in PCB in the upper side of the terminal, which is sealed in order to prevent damages. As well as avoid the interferences due to external elements inside the panel.

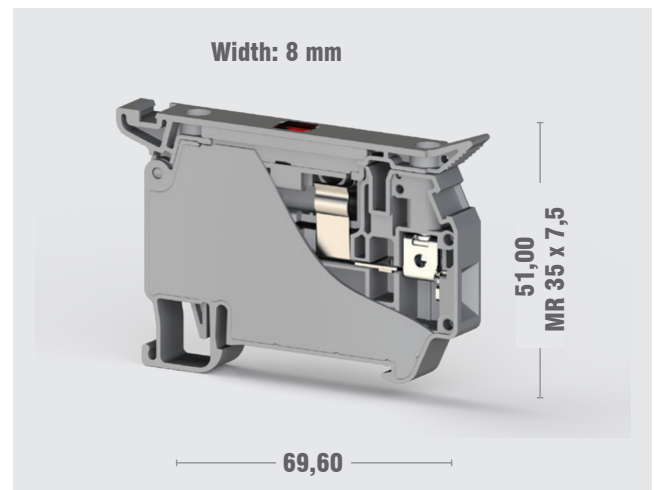

SAVE TIME IN THE INSTALLATION

UK SERIES CROSS CONNECTORS

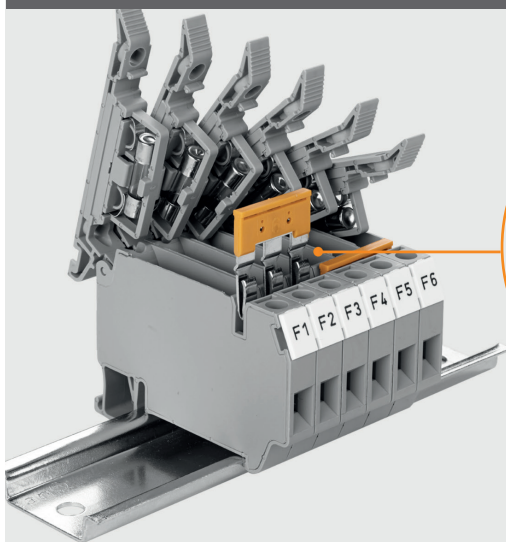

UK SERIES

The innovative design allows the connection of common points with the UK Series cross connectors.



Visit our **website** for detailed info !

Andrés Astudillo

andresastudillo@klemsan.com.tr

Kızılızüm Cad. No:15 Kemalpaşa - İZMİR / TURKEY
Tel: (+90 232) 877 08 00 - Fax: (+90 232) 877 08 06